



**ÜRÜN
KATALOĞU**
PRODUCT
CATALOGUE
2019

andora

**PLASTIC
ELECTRIC**

AVANTAJLARI

- Ürünlerimizin hafif ve dayanıklı olma özelliği,
- Zengin renk ve desenleriyle yapılarınızın dekorasyonu estetik bir uyum içerisinde oluşu,
- İstenilen ölçülerde kesilebilir ve istenen renkte boyanabilir olma özelliği,
- Pano içi delikli kablo kanallarının endüstriyel uygulamalardaki esnek kablo döşemelerinde kullanılabilmesi,
- Ürünlerimizin büyük çoğunluğunun aynı ebatlarda aksesuarlarının mevcudiyeti,
- Kablo kanallarındaki geçmeli sistemin montaj kolaylığı sağlaması,
- Mükemmel kalıp tasarımı sayesinde üstün yüzey düzgünlüğü,
- Tadilatlı uygulamalar duvarda sıva hatalarına neden olurken, kablo kanalları uygulaması duvarlarınızın kırılıp dökülerek deforme olmasını önler,
- Kanal içindeki ray sistemiyle kabloların birbirinden bağımsız bir şekilde taşınabilmesi, aynı kanaldan birden fazla kablo geçirilebilir olması özelliği,
- Priz ve anahtar montajında geçmeli montaj özelliği sayesinde pratik ve kolay sabitleme özelliği, kolay montaj,
- Kanal gövdesindeki delikler sayesinde hızlı montaj olanağı, sabitleme ayakları sayesinde kolay anahtar ve priz montajı yapılabilmesi
- Elektrik kablolarının ve bilgisayar sistemlerinin düzenlenmesinde, asansör ve doğalgaz boru kapatmalarında, prefabrik yapılar ve güvenlik sistemlerinde yaygın kullanım.

ADVANTAGES

- Our products are light-weighted and durable,
- Our products are in aesthetic harmony with the decoration of your buildings by virtue of rich color and pattern options,
- Our products can be tailor-cut to the desired dimensions and can be painted to desired color,
- Perforated cable trunking can be used at flexible cable installations for industrial practices,
- Availability of cable trunking accessories with identical sizes for majority of our products,
- Ease of assembly through click-fit system at cable trunking,
- Superior surface smoothness by virtue of excellent die design,
- While modification practices cause plaster errors on your walls, cable trunking applications prevent deformation of your walls due to demolition,
- The rail system within the trunking enables installation of cables independently and multiple cables can be laid inside the same trunking,
- Practical and easy fixation and easy assembly by virtue of click-fit assembly feature of power outlets and switches,
- Quick assembly by virtue of pre-drilled perforations on the trunking body and easy switch and socket assembly by virtue of fixing tool,
- Extensive usage for arrangement of electrical wiring and computer systems, elevator and natural gas piping enclosures and prefabricated structures and security systems.

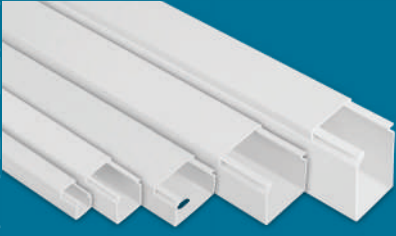

PVC KABLO KANALLARI

PVC CABLE TRUNKS

2-6



YAPIŞKAN BANTLI, PVC KABLO KANALLARI

ADHESIVE TAPE PVC CABLE TRUNKS

7-11

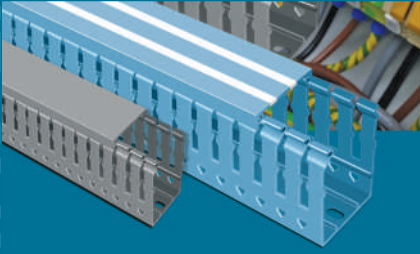

DELİKLİ (PANO TİPİ) PVC KABLO KANALLARI (GRİ / MAVİ / BEYAZ)

PVC SLOTTED CABLE TRUNKS (GREY / BLUE / WHITE)

12-20



PANOLAR BOARDS

21-28



MENHOLLER ve RÖGAR KAPAKLARI

UNDERGROUND BOARD

29-32



PANO VE DAĞITIM KUTULARI

PANEL AND DISTRIBUTION BOXES

33-35



TERMOPLASTİK BUATLAR

THERMOPLASTIC JUNCTION BOXES

36-44



TESİSAT MALZEMELERİ

INSTALLATION MATERIALS

45-52

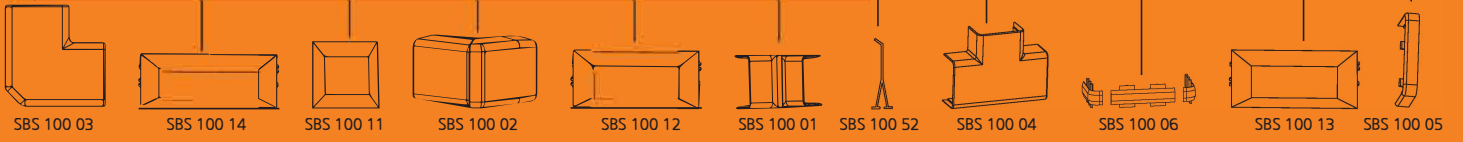

Alev almaz.
Nonflammable.



İstenilen renkte
boyanabilir.
Can be painted to
any color you desire.



Aşırı soğuğa ve
sıcağa dayanıklıdır.
Resistant to extreme
cold, heat and fire.



Çift taraflı bant
kullanarak montaj
yapabilirsiniz.
Adhesive models are
easy to install.



100x35

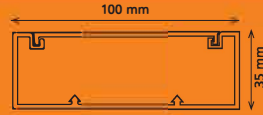

Ürün Kodu	Product Code	SBS 10035
Uzunluk	Lenght	2m
Kesit	Section	100x35
Ambalaj miktarı (m)	Package total (m)	24m
Ambalaj şekli	Package	Koli-Box
Ağırlık (kg)	Weight (kg)	21.5 kg
Hacim (m ³)	Volume (m ³)	0.075 m ³

2 ara bölme takılabilir. Upto 2 divider possibility

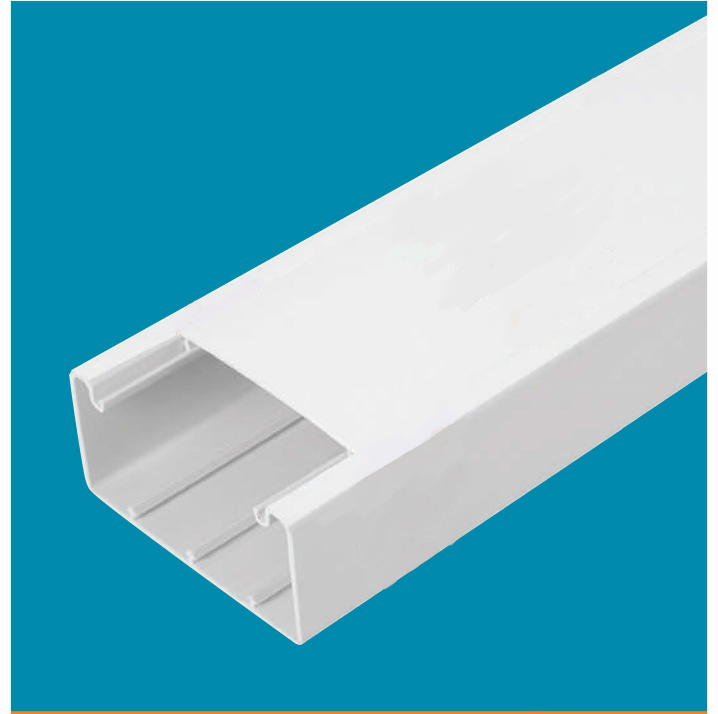

100x50

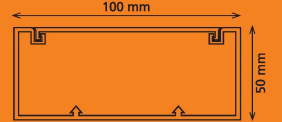

Ürün Kodu	Product Code	SBS 10050
Uzunluk	Lenght	2m
Kesit	Section	100x50
Ambalaj miktarı (m)	Package total (m)	24m
Ambalaj şekli	Package	Koli-Box
Ağırlık (kg)	Weight (kg)	21.50 kg
Hacim (m ³)	Volume (m ³)	0.094 m ³

2 ara bölme takılabilir. Upto 2 divider possibility

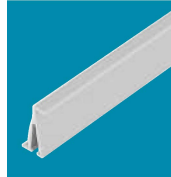

SBS 100 52 ARA BÖLME DIVIDER

Uzunluk: 2m - Lenght: 2m
Ambalaj miktarı (m): Package total (m): 140m
Hacim (m³): Volume (m³): 0.0404 m³
Ağırlık (kg): Weight (kg): 20.2

MONTAJ TAMAMLAMA AKSESUARLARI / ASSEMBLY ACCESSORIES



SBS 100 01
İç köşe (Hareketli)
Internal corner (Adjustable)
Ambalaj: 12 adet
Packaging: 12 pcs.



SBS 100 02
Dış köşe (Hareketli)
External corner (Adjustable)
Ambalaj: 10 adet
Packaging: 10 pcs.



SBS 100 03
Dirsek 90°
90° corner piece
Ambalaj: 12 adet
Packaging: 12 pcs.



SBS 100 04
T Dirsek
T Branches
Ambalaj: 12 adet
Packaging: 12 pcs.



SBS 100 05
Sonlandırma kapağı
End cover
Ambalaj: 24 adet
Packaging: 24 pcs.



SBS 100 06
Kanal birleştirme parçası
Junction piece
Ambalaj: 24 adet
Packaging: 24 pcs.

ANAHTAR PRİZ MONTAJ AKSESUARLARI / SWITCH SOCKET NETWORK ASSEMBLY SETS

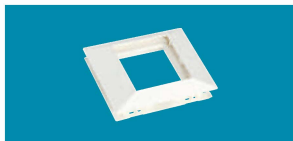

SBS 100 11
Tekli 45 x 45 Kaide (2 modül)
Top cover set for 45 x 45 (2 module)
Ambalaj: 12 adet
Packaging: 12 pcs.

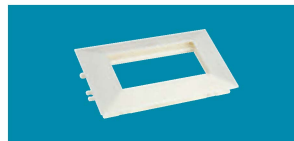

SBS 100 12
İkili 45 x 45 Kaide (4 modül)
Double top cover set for 45 x 45 (4 module)
Ambalaj: 12 adet
Packaging: 12 pcs.

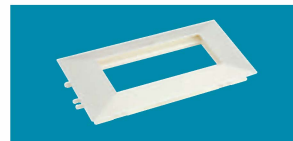

SBS 100 13
Üçlü 45 x 45 Kaide (6 modül)
Triple top cover set for 45 x 45 (6 module)
Ambalaj: 12 adet
Packaging: 12 pcs.

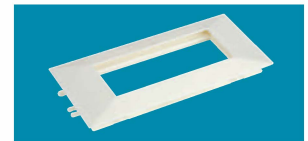

SBS 100 14
Dörtlü 45 x 45 Kaide (8 modül)
Quadruple top cover set for 45 x 45 (8 module)
Ambalaj: 20 adet
Packaging: 20 pcs.

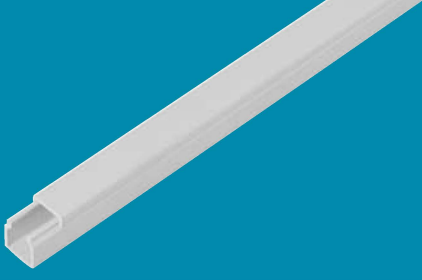

12x12



Ürün Kodu	Product Code	SBS-1012 012
Uzunluk	Lenght	2m
Kesit	Section	12x12
Ambalaj miktarı (m)	Package total (m)	300m
Ambalaj şekli	Package	Koli-Box
Ağırlık (kg)	Weight (kg)	17.50 kg
Hacim (m ³)	Volume (m ³)	0.053 m ³

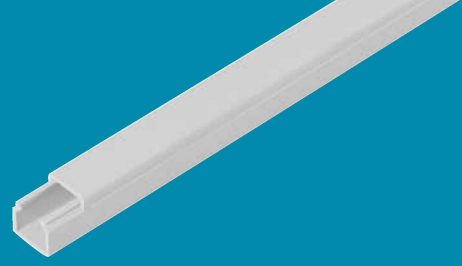

15x10



Ürün Kodu	Product Code	SBS-1015 010
Uzunluk	Lenght	2m
Kesit	Section	15x10
Ambalaj miktarı (m)	Package total (m)	288m
Ambalaj şekli	Package	Koli-Box
Ağırlık (kg)	Weight (kg)	20.60 kg
Hacim (m ³)	Volume (m ³)	0.051 m ³

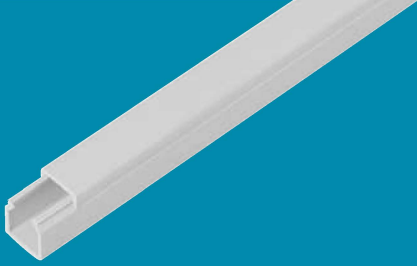

16x16

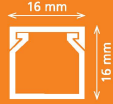

Ürün Kodu	Product Code	SBS-1016 016
Uzunluk	Lenght	2m
Kesit	Section	16x16
Ambalaj miktarı (m)	Package total (m)	250m
Ambalaj şekli	Package	Koli-Box
Ağırlık (kg)	Weight (kg)	19.50 kg
Hacim (m ³)	Volume (m ³)	0.0749 m ³

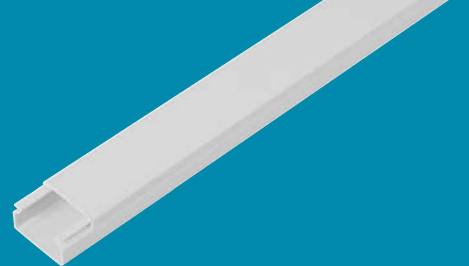

20x10

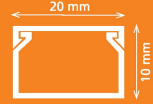

Ürün Kodu	Product Code	SBS-1020 010
Uzunluk	Lenght	2m
Kesit	Section	20x10
Ambalaj miktarı (m)	Package total (m)	200m
Ambalaj şekli	Package	Koli-Box
Ağırlık (kg)	Weight (kg)	16.00 kg
Hacim (m ³)	Volume (m ³)	0.0720 m ³

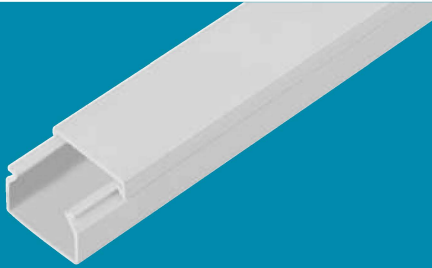

25x16



Ürün Kodu	Product Code	SBS-1025 016
Uzunluk	Lenght	2m
Kesit	Section	25x16
Ambalaj miktarı (m)	Package total (m)	150m
Ambalaj şekli	Package	Koli-Box
Ağırlık (kg)	Weight (kg)	18.50 kg
Hacim (m ³)	Volume (m ³)	0.0749 m ³

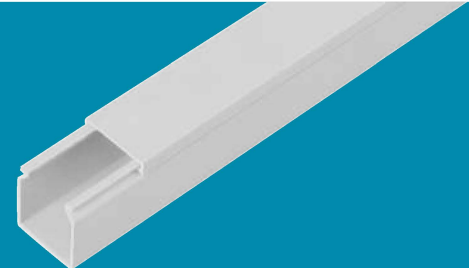

25x25



Ürün Kodu	Product Code	SBS-1025 025
Uzunluk	Lenght	2m
Kesit	Section	25x25
Ambalaj miktarı (m)	Package total (m)	100m
Ambalaj şekli	Package	Koli-Box
Ağırlık (kg)	Weight (kg)	15.50 kg
Hacim (m ³)	Volume (m ³)	0.0749 m ³

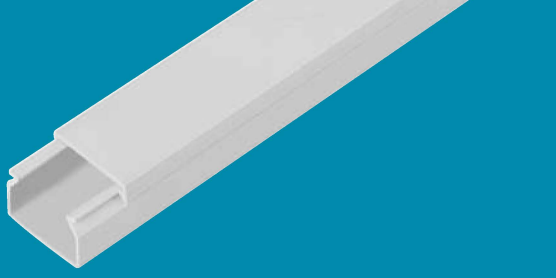

30x16

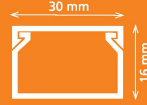

Ürün Kodu	Product Code	SBS-1030 016
Uzunluk	Lenght	2m
Kesit	Section	30x16
Ambalaj miktarı (m)	Package total (m)	136m
Ambalaj şekli	Package	Koli-Box
Ağırlık (kg)	Weight (kg)	20.00 kg
Hacim (m ³)	Volume (m ³)	0.0749 m ³



40x16



Ürün Kodu	Product Code	SBS-1040 016
Uzunluk	Lenght	2m
Kesit	Section	40x16
Ambalaj miktarı (m)	Package total (m)	100m
Ambalaj şekli	Package	Koli-Box
Ağırlık (kg)	Weight (kg)	23.00 kg
Hacim (m ³)	Volume (m ³)	0.0749 m ³



40x25

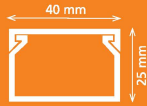

Ürün Kodu	Product Code	SBS-1040 025
Uzunluk	Lenght	2m
Kesit	Section	40x25
Ambalaj miktarı (m)	Package total (m)	84m
Ambalaj şekli	Package	Koli-Box
Ağırlık (kg)	Weight (kg)	18.50 kg
Hacim (m ³)	Volume (m ³)	0.0934 m ³

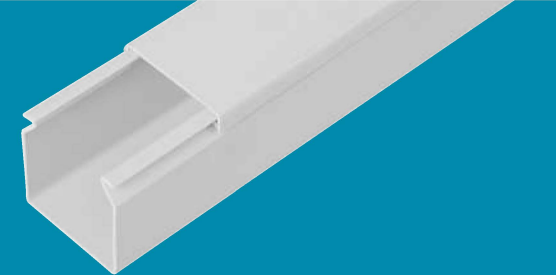

40x40

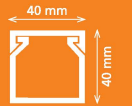

Ürün Kodu	Product Code	SBS-1040 040
Uzunluk	Lenght	2m
Kesit	Section	40x40
Ambalaj miktarı (m)	Package total (m)	50m
Ambalaj şekli	Package	Koli-Box
Ağırlık (kg)	Weight (kg)	14.00 kg
Hacim (m ³)	Volume (m ³)	0.0934 m ³



40x60



Ürün Kodu	Product Code	SBS-1040 060
Uzunluk	Lenght	2m
Kesit	Section	40x60
Ambalaj miktarı (m)	Package total (m)	40m
Ambalaj şekli	Package	Koli-Box
Ağırlık (kg)	Weight (kg)	21.40 kg
Hacim (m ³)	Volume (m ³)	0.0749 m ³



60x25

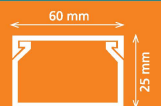

Ürün Kodu	Product Code	SBS-1060 025
Uzunluk	Lenght	2m
Kesit	Section	60x25
Ambalaj miktarı (m)	Package total (m)	40m
Ambalaj şekli	Package	Koli-Box
Ağırlık (kg)	Weight (kg)	13.50 kg
Hacim (m ³)	Volume (m ³)	0.0749 m ³



60x40

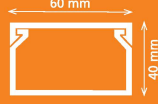

Ürün Kodu	Product Code	SBS-1060 040
Uzunluk	Lenght	2m
Kesit	Section	60x40
Ambalaj miktarı (m)	Package total (m)	40m
Ambalaj şekli	Package	Koli-Box
Ağırlık (kg)	Weight (kg)	16.50 kg
Hacim (m ³)	Volume (m ³)	0.0892 m ³



60x60

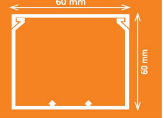

Ürün Kodu	Product Code	SBS-1060 060
Uzunluk	Lenght	2m
Kesit	Section	40x40
Ambalaj miktarı (m)	Package total (m)	32m
Ambalaj şekli	Package	Koli-Box
Ağırlık (kg)	Weight (kg)	17.00 kg
Hacim (m ³)	Volume (m ³)	0.0749 m ³



80x40

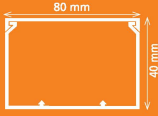

Ürün Kodu	Product Code	SBS-1080 040
Uzunluk	Lenght	2m
Kesit	Section	80x40
Ambalaj miktarı (m)	Package total (m)	36m
Ambalaj şekli	Package	Koli-Box
Ağırlık (kg)	Weight (kg)	21.00 kg
Hacim (m ³)	Volume (m ³)	0.0749 m ³



80x60

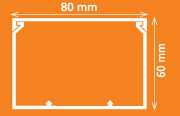

Ürün Kodu	Product Code	SBS-1080 060
Uzunluk	Lenght	2m
Kesit	Section	80x60
Ambalaj miktarı (m)	Package total (m)	24m
Ambalaj şekli	Package	Koli-Box
Ağırlık (kg)	Weight (kg)	17.80 kg
Hacim (m ³)	Volume (m ³)	0.0749 m ³

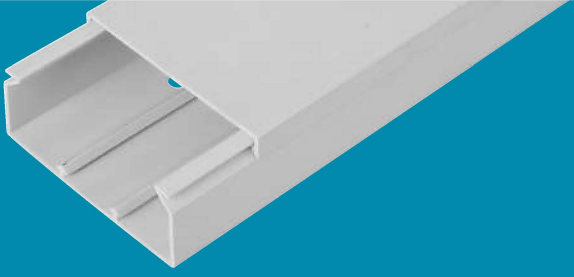

100x40

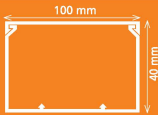

Ürün Kodu	Product Code	SBS-10100 040
Uzunluk	Lenght	2m
Kesit	Section	100x40
Ambalaj miktarı (m)	Package total (m)	24m
Ambalaj şekli	Package	Koli-Box
Ağırlık (kg)	Weight (kg)	15.50 kg
Hacim (m ³)	Volume (m ³)	0.0749 m ³



100x60

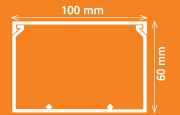

Ürün Kodu	Product Code	SBS-10100 060
Uzunluk	Lenght	2m
Kesit	Section	100x60
Ambalaj miktarı (m)	Package total (m)	24m
Ambalaj şekli	Package	Koli-Box
Ağırlık (kg)	Weight (kg)	18.40 kg
Hacim (m ³)	Volume (m ³)	0.0934 m ³

YAPIŞKAN BANTLI,
PVC KABLO KANALLARI

ADHESIVE TAPE PVC
CABLE TRUNKS





12x12



Ürün Kodu	Product Code	SBS-2012 012
Uzunluk	Lenght	2m
Kesit	Section	12x12
Ambalaj miktarı (m)	Package total (m)	300m
Ambalaj şekli	Package	Koli-Box
Ağırlık (kg)	Weight (kg)	18.00 kg
Hacim (m ³)	Volume (m ³)	0.0530 m ³

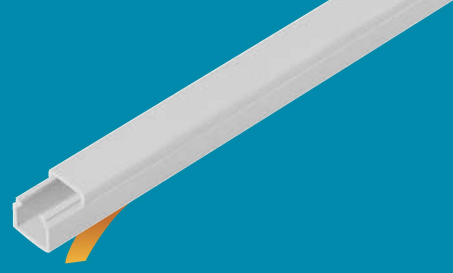

15x10



Ürün Kodu	Product Code	SBS-2015 010
Uzunluk	Lenght	2m
Kesit	Section	15x10
Ambalaj miktarı (m)	Package total (m)	288m
Ambalaj şekli	Package	Koli-Box
Ağırlık (kg)	Weight (kg)	17.50 kg
Hacim (m ³)	Volume (m ³)	0.0591 m ³

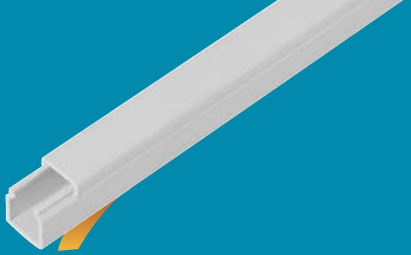

16x16

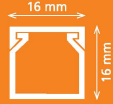

Ürün Kodu	Product Code	SBS-2016 016
Uzunluk	Lenght	2m
Kesit	Section	16x16
Ambalaj miktarı (m)	Package total (m)	250m
Ambalaj şekli	Package	Koli-Box
Ağırlık (kg)	Weight (kg)	20.00 kg
Hacim (m ³)	Volume (m ³)	0.0749 m ³



20x10

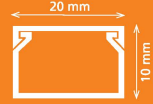

Ürün Kodu	Product Code	SBS-2020 010
Uzunluk	Lenght	2m
Kesit	Section	20x10
Ambalaj miktarı (m)	Package total (m)	200m
Ambalaj şekli	Package	Koli-Box
Ağırlık (kg)	Weight (kg)	16.50 kg
Hacim (m ³)	Volume (m ³)	0.0750 m ³



25x16

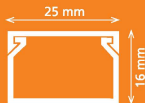

Ürün Kodu	Product Code	SBS-2025 016
Uzunluk	Lenght	2m
Kesit	Section	25x16
Ambalaj miktarı (m)	Package total (m)	150m
Ambalaj şekli	Package	Koli-Box
Ağırlık (kg)	Weight (kg)	19.00 kg
Hacim (m ³)	Volume (m ³)	0.0749 m ³



25x25



Ürün Kodu	Product Code	SBS-2025 025
Uzunluk	Lenght	2m
Kesit	Section	25x25
Ambalaj miktarı (m)	Package total (m)	100m
Ambalaj şekli	Package	Koli-Box
Ağırlık (kg)	Weight (kg)	16.40 kg
Hacim (m ³)	Volume (m ³)	0.0749 m ³

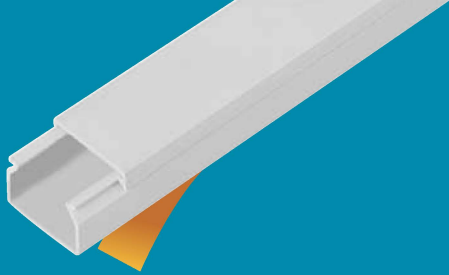

30x16



Ürün Kodu	Product Code	SBS-2030 016
Uzunluk	Lenght	2m
Kesit	Section	30x16
Ambalaj miktarı (m)	Package total (m)	100m
Ambalaj şekli	Package	Koli-Box
Ağırlık (kg)	Weight (kg)	20.50 kg
Hacim (m ³)	Volume (m ³)	0.0749 m ³

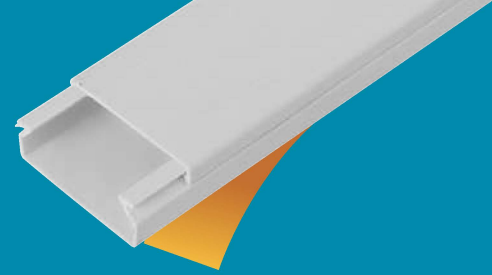

40x16



Ürün Kodu	Product Code	SBS-2040 016
Uzunluk	Lenght	2m
Kesit	Section	40x16
Ambalaj miktarı (m)	Package total (m)	100m
Ambalaj şekli	Package	Koli-Box
Ağırlık (kg)	Weight (kg)	23.50 kg
Hacim (m ³)	Volume (m ³)	0.0749 m ³

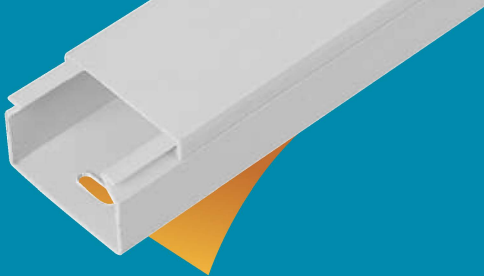

40x25

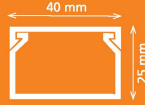

Ürün Kodu	Product Code	SBS-2040 025
Uzunluk	Lenght	2m
Kesit	Section	40x25
Ambalaj miktarı (m)	Package total (m)	84m
Ambalaj şekli	Package	Koli-Box
Ağırlık (kg)	Weight (kg)	19.00 kg
Hacim (m ³)	Volume (m ³)	0.0934 m ³

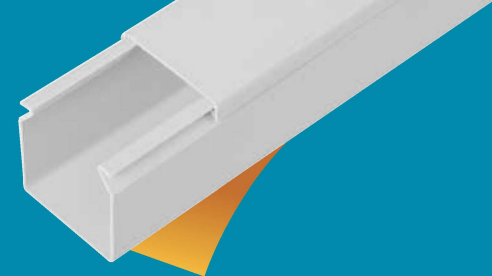

40x40

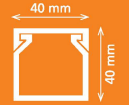

Ürün Kodu	Product Code	SBS-2040 040
Uzunluk	Lenght	2m
Kesit	Section	40x40
Ambalaj miktarı (m)	Package total (m)	50m
Ambalaj şekli	Package	Koli-Box
Ağırlık (kg)	Weight (kg)	14.60 kg
Hacim (m ³)	Volume (m ³)	0.0934 m ³



ZEMİN ÜSTÜ (BALIK SIRTI) PVC KABLO KANALLARI OVERFLOOR PVC CABLE TRUNKS



Ürün Kodu	Product Code	SBS-7050 012
Uzunluk	Lenght	2m
Kesit	Section	50x12
Ambalaj miktarı (m)	Package total (m)	60m
Ambalaj şekli	Package	Koli-Box
Ağırlık (kg)	Weight (kg)	15,50 kg
Hacim (m ³)	Volume (m ³)	0.0531 m ³
Renk:Gri-Beyaz	Color:Grey-White	
Kendinden ara bölmeli	Self-division	



Ürün Kodu	Product Code	SBS-7070 020
Uzunluk	Lenght	2m
Kesit	Section	70x20
Ambalaj miktarı (m)	Package total (m)	60m
Ambalaj şekli	Package	Koli-Box
Ağırlık (kg)	Weight (kg)	27.50 kg
Hacim (m ³)	Volume (m ³)	0.0750 m ³
Renk:Gri-Beyaz	Color:Grey-White	
Kendinden ara bölmeli	Self-division	

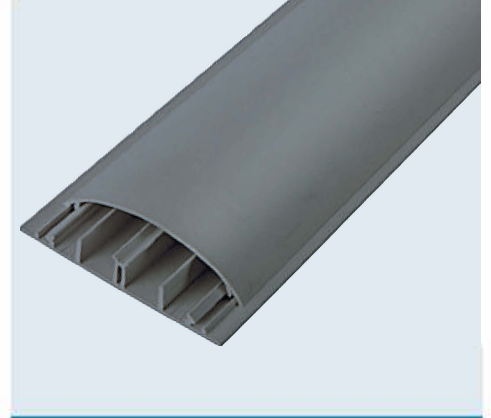

Ürün Kodu	Product Code	SBS-7090 020
Uzunluk	Lenght	2m
Kesit	Section	90x20
Ambalaj miktarı (m)	Package total (m)	20m
Ambalaj şekli	Package	Koli-Box
Ağırlık (kg)	Weight (kg)	20.40 kg
Hacim (m ³)	Volume (m ³)	0.0530 m ³
Renk:Gri-Beyaz	Color:Grey-White	
Kendinden ara bölmeli	Self-division	

ZEMİN ÜSTÜ (BALIK SIRTI) PVC KABLO KANALLARI (YAPIŞKAN BANTLI) OVERFLOOR PVC CABLE TRUNKS ADHESIVE TAPE



Ürün Kodu	Product Code	SBS-8050 012
Uzunluk	Lenght	2m
Kesit	Section	50x12
Ambalaj miktarı (m)	Package total (m)	60m
Ambalaj şekli	Package	Koli-Box
Ağırlık (kg)	Weight (kg)	16.00 kg
Hacim (m ³)	Volume (m ³)	0.0531 m ³
Renk:Gri-Beyaz	Color:Grey-White	
Kendinden ara bölmeli	Self-division	



Ürün Kodu	Product Code	SBS-8070 020
Uzunluk	Lenght	2m
Kesit	Section	70x20
Ambalaj miktarı (m)	Package total (m)	60m
Ambalaj şekli	Package	Koli-Box
Ağırlık (kg)	Weight (kg)	28.00 kg
Hacim (m ³)	Volume (m ³)	0.0750 m ³
Renk:Gri-Beyaz	Color:Grey-White	
Kendinden ara bölmeli	Self-division	

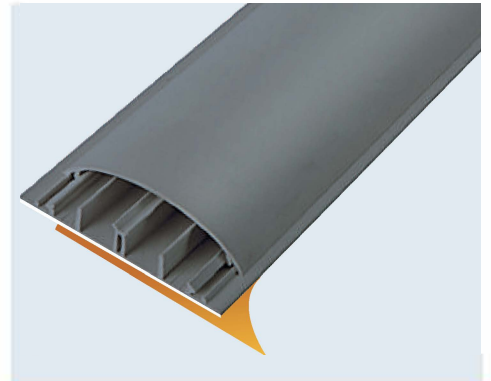

Ürün Kodu	Product Code	SBS-8090 020
Uzunluk	Lenght	2m
Kesit	Section	90x20
Ambalaj miktarı (m)	Package total (m)	20m
Ambalaj şekli	Package	Koli-Box
Ağırlık (kg)	Weight (kg)	20.60 kg
Hacim (m ³)	Volume (m ³)	0.0530 m ³
Renk:Gri-Beyaz	Color:Grey-White	
Kendinden ara bölmeli	Self-division	

RENKLİ KABLO KANALLARI

COLOURS CABLE TRUNKS

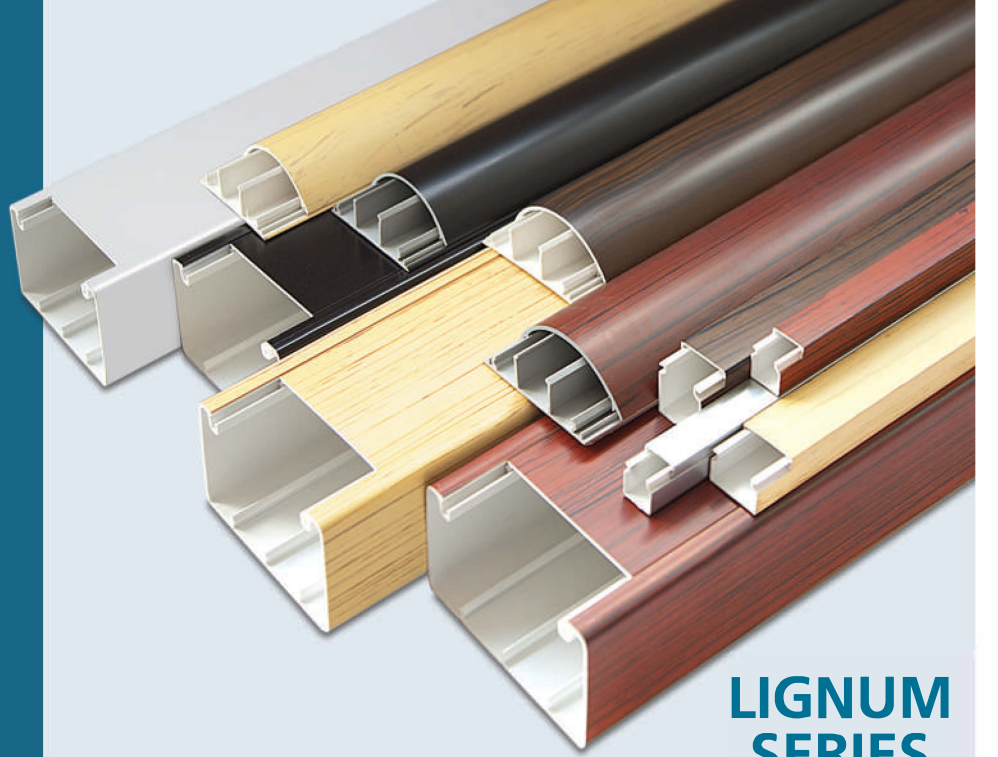

LIGNUM SERIES

RENK SEÇENEKLERİ COLOUR OPTIONS



Gümüş / Silver



Siyah / Black



Kayın / Beech

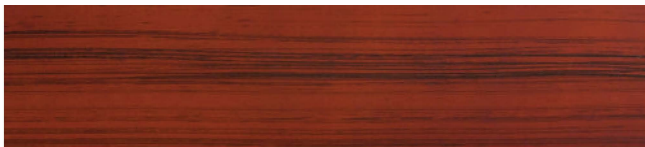

Maun / Mahogany



Ceviz / Walnut



**DELİKLİ (PANO TİPİ)
PVC KABLO KANALLARI
(GRİ / MAVİ / BEYAZ)**

PVC SLOTTED CABLE
TRUNKS
(GREY / BLUE
/ BEYAZ)

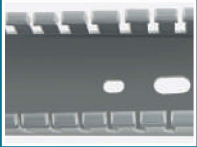

Tabanındaki delikler sayesinde hızlı ve kolay montaj sağlar.

Holes in the base allows quick and easy installation



Kesici aletlerle kolayca dilediğiniz ebatta kesebilirsiniz.

With Special Cutting tools, you can easily cut the trunking as your desired size.



Ekstra dayanıklılık sağlayan kapak ve gövde birleşimi.

The combination of the body and cover parts provide extra durability.

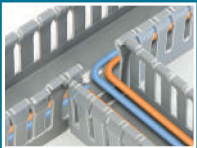

Tırnakları kırarak dilediğiniz yerden T bağlantılar yapabilirsiniz.

T connections can be made by breaking side nails.



Önceden belirlenmiş kırılma hatları sayesinde kanal birleştirme ve kablo çıkışı yapabilirsiniz.

With its predesigned breaking lines, vast unit of cable joint and cable outputs.



Kablo çıkışları için düzenli aralıklar

Regular space intervals for cable output

DELİKLİ (PANO TİPİ) PVC KABLO KANALLARI (GRİ / MAVİ)

PVC SLOTTED CABLE TRUNKS (GREY / BLUE)

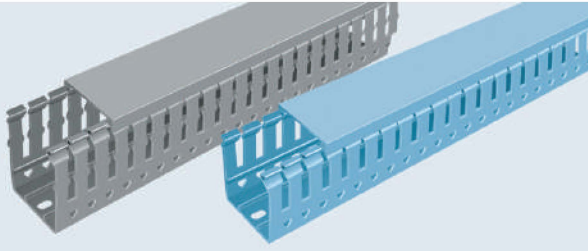
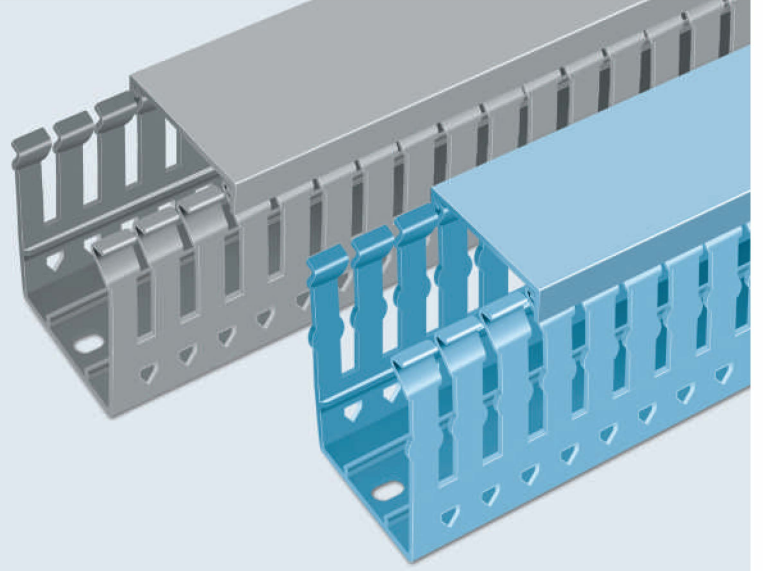

25x25

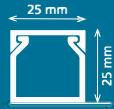

Grey: SBS-3025 025 Blue : SBS-6025 025 White: SBS-9025 025

Uzunluk	Lenght	2m
Kesit	Section	25x25
Ambalaj miktarı (m)	Package total (m)	100m
Ambalaj şekli	Package	Koli-Box
Ağırlık (kg)	Weight (kg)	20.15 kg
Hacim (m ³)	Volume (m ³)	0.0749 m ³

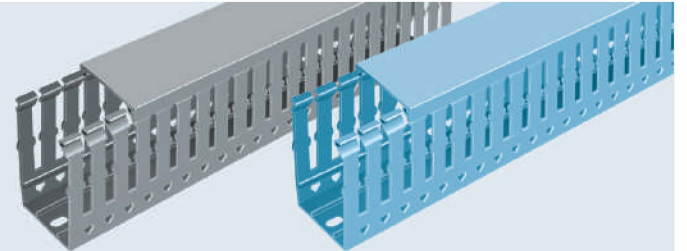

25x40

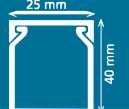

Grey: SBS-3025 040 Blue : SBS-6025 040 White: SBS-9025 040

Uzunluk	Lenght	2m
Kesit	Section	25x40
Ambalaj miktarı (m)	Package total (m)	80m
Ambalaj şekli	Package	Koli-Box
Ağırlık (kg)	Weight (kg)	19.50 kg
Hacim (m ³)	Volume (m ³)	0.0890 m ³

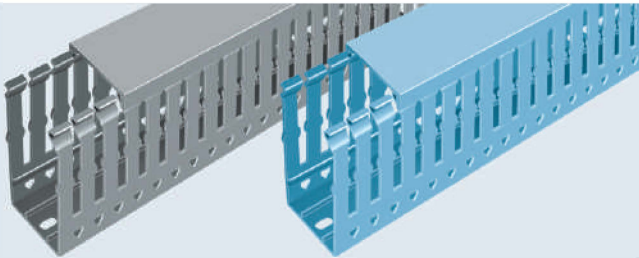

25x60

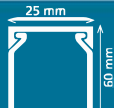

Grey: SBS-3025 060 Blue : SBS-6025 060 White: SBS-9025 060

Uzunluk	Lenght	2m
Kesit	Section	25x60
Ambalaj miktarı (m)	Package total (m)	72m
Ambalaj şekli	Package	Koli-Box
Ağırlık (kg)	Weight (kg)	26.50 kg
Hacim (m ³)	Volume (m ³)	0.1262 m ³

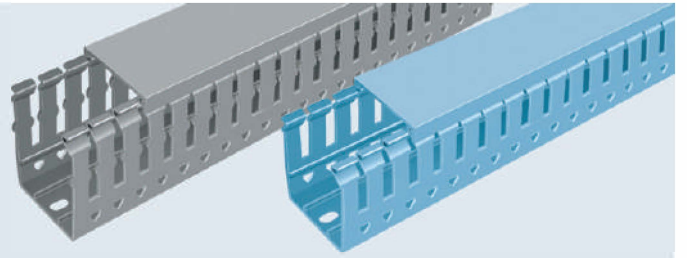

40x40

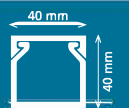

Grey: SBS-3040 040 Blue : SBS-6040 040 White: SBS-9040 040

Uzunluk	Lenght	2m
Kesit	Section	40x40
Ambalaj miktarı (m)	Package total (m)	72m
Ambalaj şekli	Package	Koli-Box
Ağırlık (kg)	Weight (kg)	25.50 kg
Hacim (m ³)	Volume (m ³)	0.1262 m ³

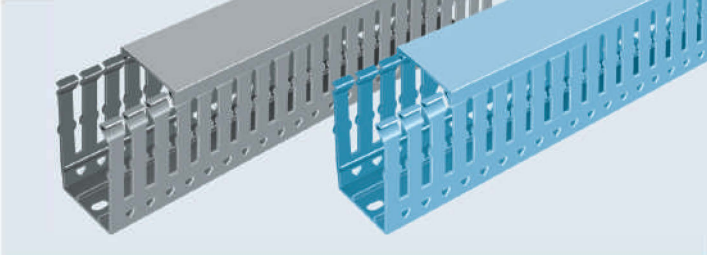
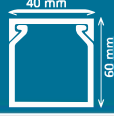
**40x60**

Grey: SBS-3040 060 Blue : SBS-6040 060 White: SBS-9040 060

Uzunluk	Lenght	2m
Kesit	Section	40x60
Ambalaj miktarı (m)	Package total (m)	48m
Ambalaj şekli	Package	Koli-Box
Ağırlık (kg)	Weight (kg)	23.00 kg
Hacim (m ³)	Volume (m ³)	0.126 m ³

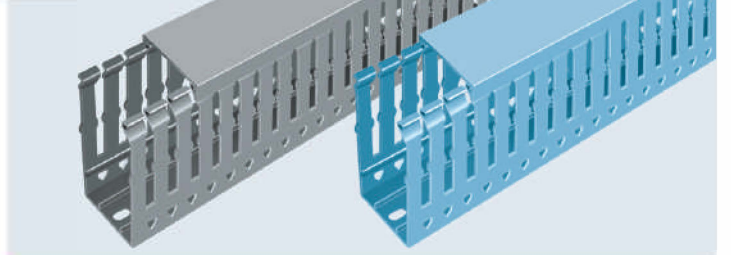
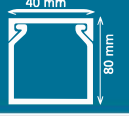
**40x80**

Grey: SBS-3040 080 Blue : SBS-6040 080 White: SBS-9040 080

Uzunluk	Lenght	2m
Kesit	Section	40x80
Ambalaj miktarı (m)	Package total (m)	36m
Ambalaj şekli	Package	Koli-Box
Ağırlık (kg)	Weight (kg)	22.30 kg
Hacim (m ³)	Volume (m ³)	0.126 m ³

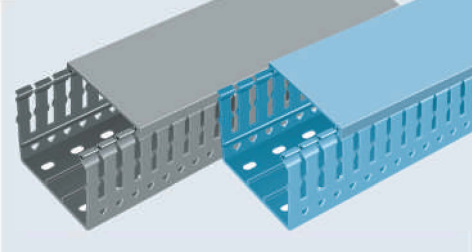
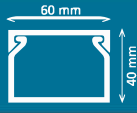
**60x40**

Grey: SBS-3060 040 Grey: SBS-6060 040 White: SBS-9060 040

Uzunluk	Lenght	2m
Kesit	Section	40x60
Ambalaj miktarı (m)	Package total (m)	48m
Ambalaj şekli	Package	Koli-Box
Ağırlık (kg)	Weight (kg)	23.00 kg
Hacim (m ³)	Volume (m ³)	0.126 m ³

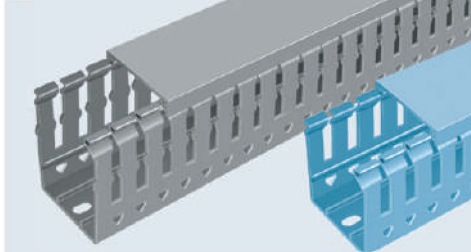
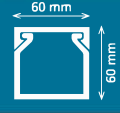
**60x60**

Grey: SBS-3060 060 Blue : SBS-6060 060 White: SBS-9060 060

Uzunluk	Lenght	2m
Kesit	Section	60x60
Ambalaj miktarı (m)	Package total (m)	32m
Ambalaj şekli	Package	Koli-Box
Ağırlık (kg)	Weight (kg)	20.50 kg
Hacim (m ³)	Volume (m ³)	0.126 m ³

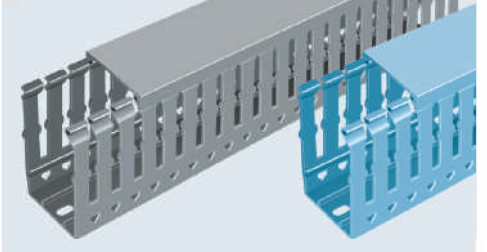
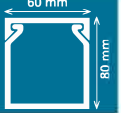
**60x80**

Grey: SBS-3060 080 Blue : SBS-6060 080 White: SBS-9060 080

Uzunluk	Lenght	2m
Kesit	Section	60x80
Ambalaj miktarı (m)	Package total (m)	24m
Ambalaj şekli	Package	Koli-Box
Ağırlık (kg)	Weight (kg)	18.00 kg
Hacim (m ³)	Volume (m ³)	0.126 m ³

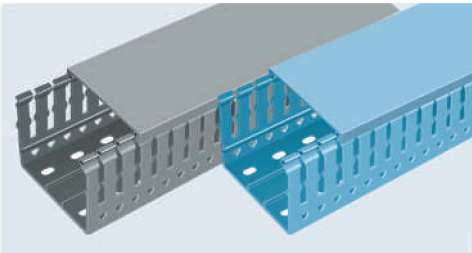
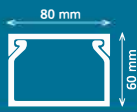
**80x60**

Grey: SBS-3080 060 Blue : SBS-6080 060 White: SBS-9080 060

Uzunluk	Lenght	2m
Kesit	Section	80x60
Ambalaj miktarı (m)	Package total (m)	24m
Ambalaj şekli	Package	Koli-Box
Ağırlık (kg)	Weight (kg)	18.00 kg
Hacim (m ³)	Volume (m ³)	0.126 m ³

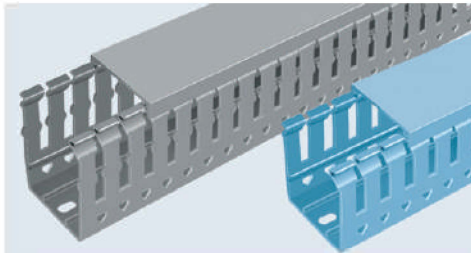
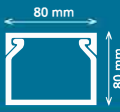
**80x80**

Grey: SBS-3080 080 Blue : SBS-6080 080 White: SBS-9080 080

Uzunluk	Lenght	2m
Kesit	Section	80x80
Ambalaj miktarı (m)	Package total (m)	18m
Ambalaj şekli	Package	Koli-Box
Ağırlık (kg)	Weight (kg)	18.00 kg
Hacim (m ³)	Volume (m ³)	0.126 m ³

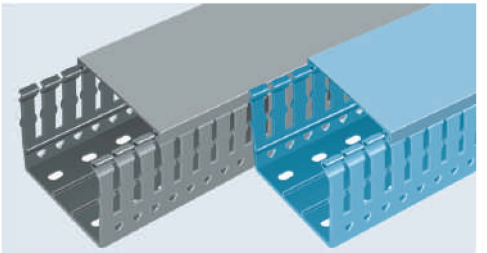
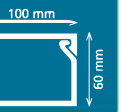
**100x60**

Grey: SBS-30100 60 Blue : SBS-60100 60 White: SBS-90100 60

Uzunluk	Lenght	2m
Kesit	Section	100x60
Ambalaj miktarı (m)	Package total (m)	18m
Ambalaj şekli	Package	Koli-Box
Ağırlık (kg)	Weight (kg)	17.50 kg
Hacim (m ³)	Volume (m ³)	0.126 m ³

**YAPIŞKAN BANTLI
DELİKLİ (PANO TİPİ)
PVC KABLO
KANALLARI
(GRİ / MAVİ)**

**ADHESIVE TAPE PVC
SLOTTED CABLE
TRUNKS
(GREY/BLUE)**

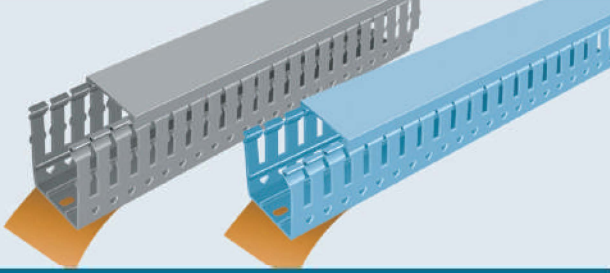
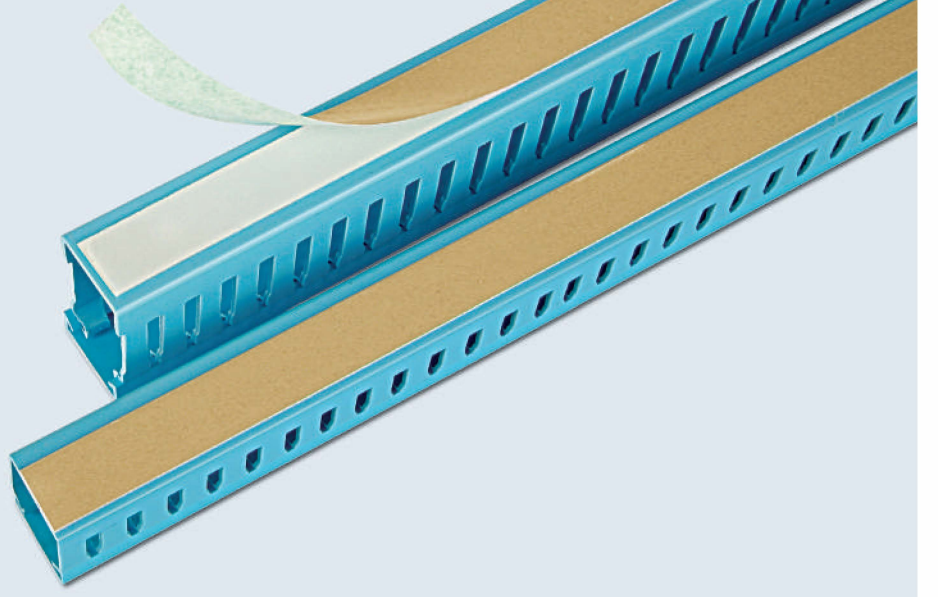

25x25

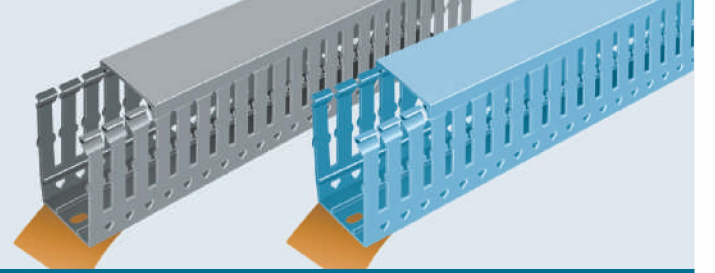
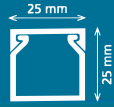

25x40

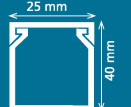

Grey: SBS-4025 025 Blue : SBS-4325 025 White: SBS-4625 025

Uzunluk	Lenght	2m
Kesit	Section	25x25
Ambalaj miktarı (m)	Package total (m)	100m
Ambalaj şekli	Package	Koli-Box
Ağırlık (kg)	Weight (kg)	20.55 kg
Hacim (m ³)	Volume (m ³)	0.0735 m ³

Grey: SBS-4025 040 Blue : SBS-4325 040 White: SBS-4625 040

Uzunluk	Lenght	2m
Kesit	Section	25x40
Ambalaj miktarı (m)	Package total (m)	80m
Ambalaj şekli	Package	Koli-Box
Ağırlık (kg)	Weight (kg)	20.00 kg
Hacim (m ³)	Volume (m ³)	0.089 m ³

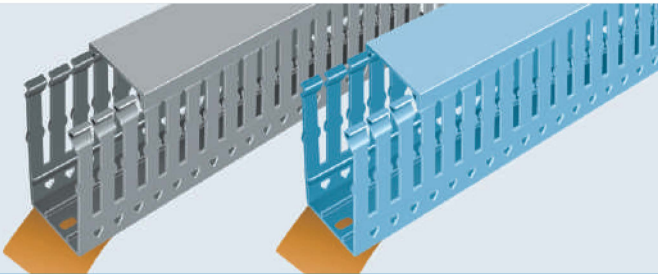

25x60

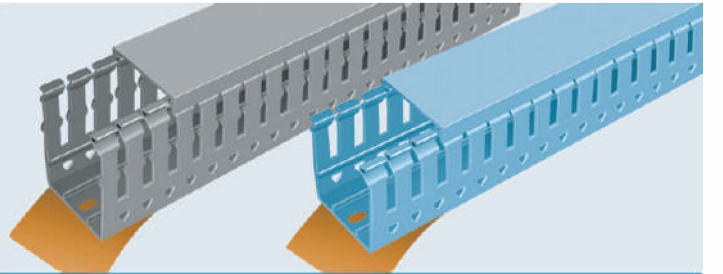
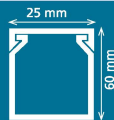

40x40

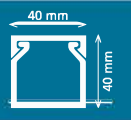

Grey: SBS-4025 060 Blue : SBS-4325 060 White: SBS-4625 060

Uzunluk	Lenght	2m
Kesit	Section	25x60
Ambalaj miktarı (m)	Package total (m)	72m
Ambalaj şekli	Package	Koli-Box
Ağırlık (kg)	Weight (kg)	27.00 kg
Hacim (m ³)	Volume (m ³)	0.119 m ³

Grey: SBS-4025 040 Blue : SBS-4325 040 White: SBS-4625 040

Uzunluk	Lenght	2m
Kesit	Section	40x40
Ambalaj miktarı (m)	Package total (m)	72m
Ambalaj şekli	Package	Koli-Box
Ağırlık (kg)	Weight (kg)	26.00 kg
Hacim (m ³)	Volume (m ³)	0.126 m ³

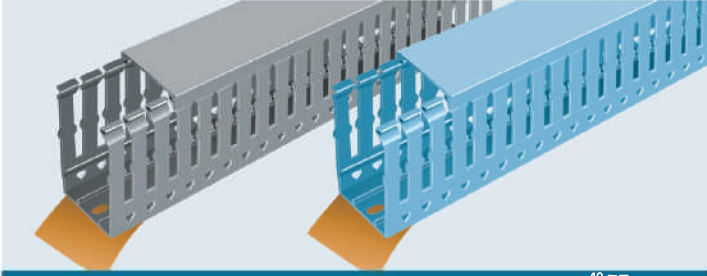

40x60

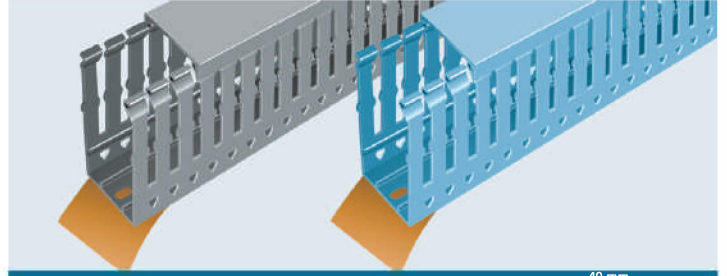
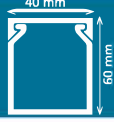

40x80

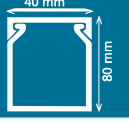

Grey: SBS-4040 060

Blue : SBS-4340 060

White: SBS-4640 060

Grey: SBS-4040 080

Blue : SBS-4340 080

White: SBS-4640 080

Uzunluk	Lenght	2m
Kesit	Section	40x60
Ambalaj miktarı (m)	Package total (m)	48m
Ambalaj şekli	Package	Koli-Box
Ağırlık (kg)	Weight (kg)	23.50 kg
Hacim (m ³)	Volume (m ³)	0.126 m ³

Uzunluk	Lenght	2m
Kesit	Section	40x80
Ambalaj miktarı (m)	Package total (m)	36m
Ambalaj şekli	Package	Koli-Box
Ağırlık (kg)	Weight (kg)	22.50 kg
Hacim (m ³)	Volume (m ³)	0.126 m ³



**BEYAZ ÇİZGİLİ
DELİKLİ (PANO TİPİ)
PVC KABLO
KANALLARI
(GRİ / MAVİ)**

**PVC SLOTTED
CABLE TRUNKS
WITH WHITE LINES
(GREY/BLUE)**

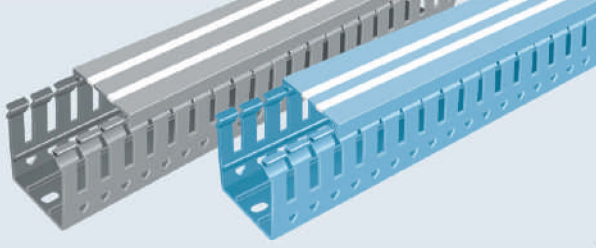
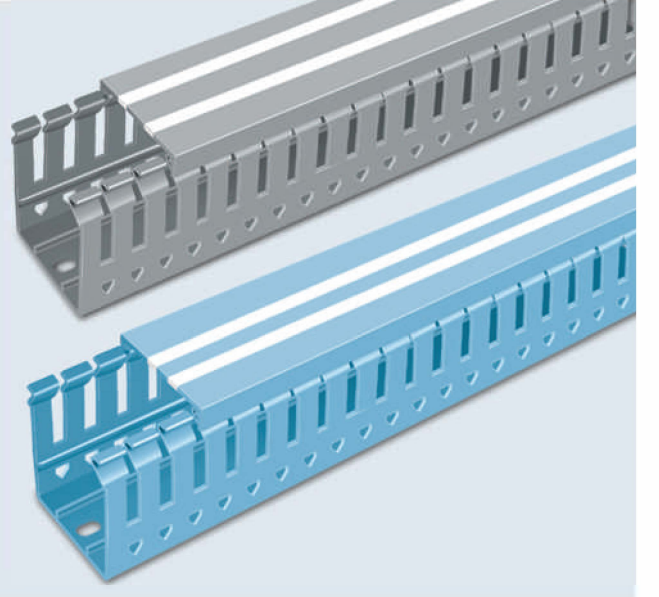

25x25

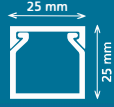

Grey: SBS-5025 025 Blue : SBS-5325 025 White: SBS-5625 025

Uzunluk	Lenght	2m
Kesit	Section	25x25
Ambalaj miktarı (m)	Package total (m)	100m
Ambalaj şekli	Package	Koli-Box
Ağırlık (kg)	Weight (kg)	20.15 kg
Hacim (m ³)	Volume (m ³)	0.0749 m ³

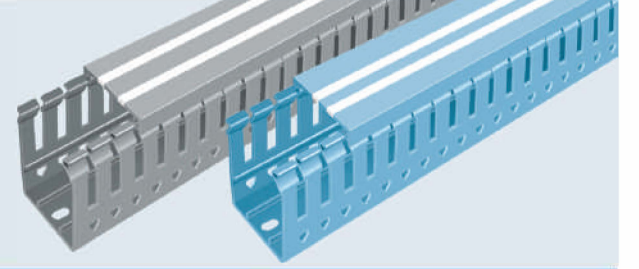

25x40

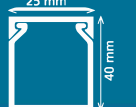

Grey: SBS-5025 040 Blue : SBS-5325 040 White: SBS-5625 040

Uzunluk	Lenght	2m
Kesit	Section	25x40
Ambalaj miktarı (m)	Package total (m)	80m
Ambalaj şekli	Package	Koli-Box
Ağırlık (kg)	Weight (kg)	19.50 kg
Hacim (m ³)	Volume (m ³)	0.089 m ³

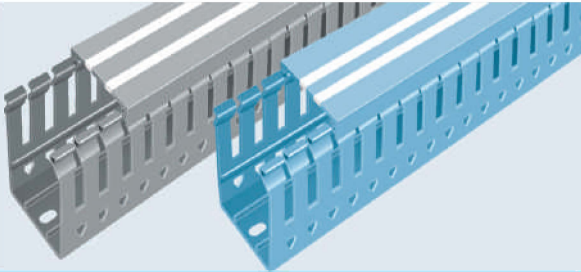

25x60

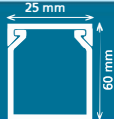

Grey: SBS-5025 060 Blue : SBS-5325 060 White: SBS-5625 060

Uzunluk	Lenght	2m
Kesit	Section	25x60
Ambalaj miktarı (m)	Package total (m)	72m
Ambalaj şekli	Package	Koli-Box
Ağırlık (kg)	Weight (kg)	26.50 kg
Hacim (m ³)	Volume (m ³)	0.126 m ³

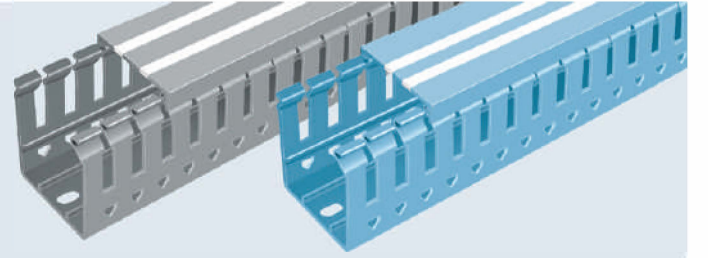

40x40

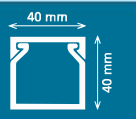

Grey: SBS-5040 040 Blue : SBS-5340 040 White: SBS-5640 040

Uzunluk	Lenght	2m
Kesit	Section	40x40
Ambalaj miktarı (m)	Package total (m)	72m
Ambalaj şekli	Package	Koli-Box
Ağırlık (kg)	Weight (kg)	25.50 kg
Hacim (m ³)	Volume (m ³)	0.126 m ³

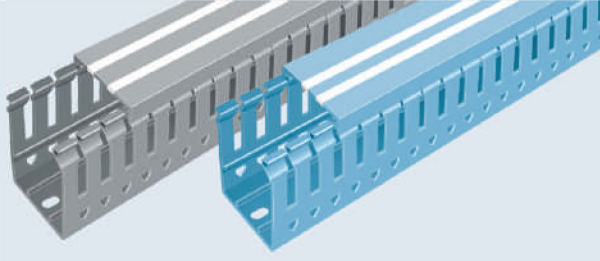

40x60

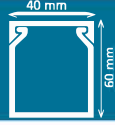

Grey: SBS-5040 060 Blue : SBS-5340 060 White: SBS-5640 060

Uzunluk	Lenght	2m
Kesit	Section	40x60
Ambalaj miktarı (m)	Package total (m)	48m
Ambalaj şekli	Package	Koli-Box
Ağırlık (kg)	Weight (kg)	23.00 kg
Hacim (m ³)	Volume (m ³)	0.126 m ³

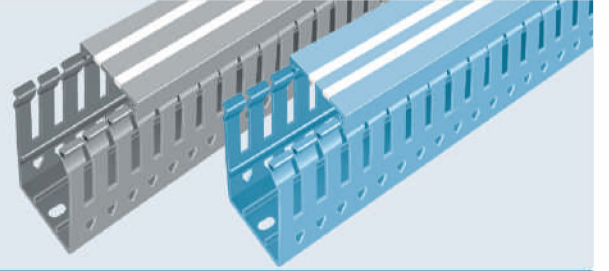

40x80

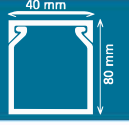

Grey: SBS-5040 080 Blue : SBS-5340 080 White: SBS-5640 080

Uzunluk	Lenght	2m
Kesit	Section	40x80
Ambalaj miktarı (m)	Package total (m)	36m
Ambalaj şekli	Package	Koli-Box
Ağırlık (kg)	Weight (kg)	22.00 kg
Hacim (m ³)	Volume (m ³)	0.126 m ³

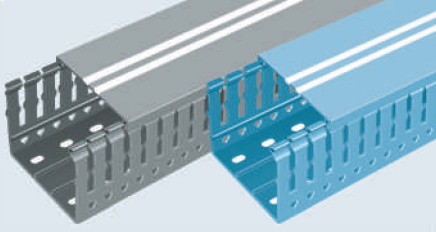

60x40

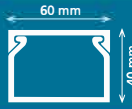

Grey: SBS-5060 040 Blue : SBS-5360 040 White: SBS-5660 040

Uzunluk	Lenght	2m
Kesit	Section	40x60
Ambalaj miktarı (m)	Package total (m)	48m
Ambalaj şekli	Package	Koli-Box
Ağırlık (kg)	Weight (kg)	23.00 kg
Hacim (m ³)	Volume (m ³)	0.126 m ³

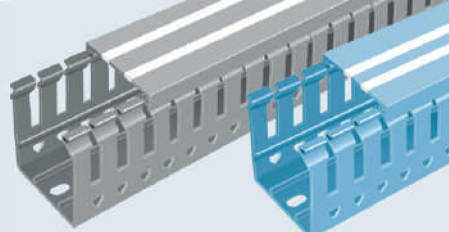

60x60

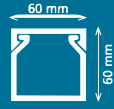

Grey: SBS-5060 060 Blue : SBS-5360 060 White: SBS-5660 060

Uzunluk	Lenght	2m
Kesit	Section	60x60
Ambalaj miktarı (m)	Package total (m)	32m
Ambalaj şekli	Package	Koli-Box
Ağırlık (kg)	Weight (kg)	20.50 kg
Hacim (m ³)	Volume (m ³)	0.126 m ³

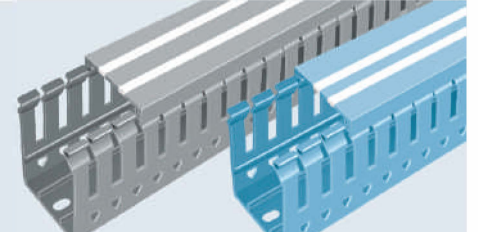

60x80

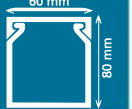

Grey: SBS-5060 080 Blue : SBS-5360 080 White: SBS-5660 080

Uzunluk	Lenght	2m
Kesit	Section	60x80
Ambalaj miktarı (m)	Package total (m)	24m
Ambalaj şekli	Package	Koli-Box
Ağırlık (kg)	Weight (kg)	18.00 kg
Hacim (m ³)	Volume (m ³)	0.126 m ³

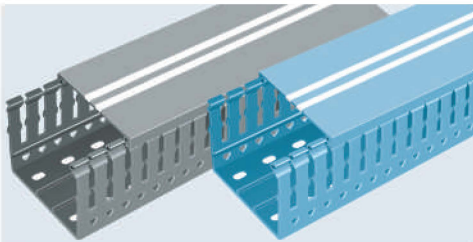

80x60

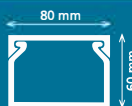

Grey: SBS-5080 060 Blue : SBS-5380 060 White: SBS-5680 060

Uzunluk	Lenght	2m
Kesit	Section	80x60
Ambalaj miktarı (m)	Package total (m)	24m
Ambalaj şekli	Package	Koli-Box
Ağırlık (kg)	Weight (kg)	18.00 kg
Hacim (m ³)	Volume (m ³)	0.126 m ³

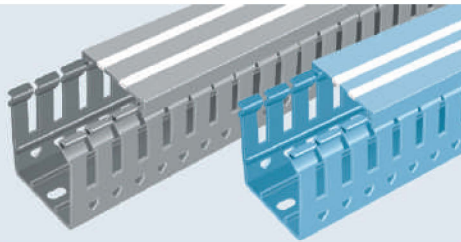

80x80



Grey: SBS-5080 080 Blue : SBS-5380 080 White: SBS-5680 080

Uzunluk	Lenght	2m
Kesit	Section	80x80
Ambalaj miktarı (m)	Package total (m)	18m
Ambalaj şekli	Package	Koli-Box
Ağırlık (kg)	Weight (kg)	18.00 kg
Hacim (m ³)	Volume (m ³)	0.126 m ³

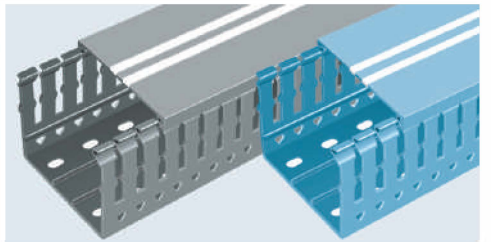

100x60

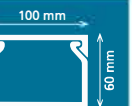

Grey: SBS-50100 60 Blue : SBS-53100 60 White: SBS-56100 60

Uzunluk	Lenght	2m
Kesit	Section	100x60
Ambalaj miktarı (m)	Package total (m)	18m
Ambalaj şekli	Package	Koli-Box
Ağırlık (kg)	Weight (kg)	17.50 kg
Hacim (m ³)	Volume (m ³)	0.126 m ³

**BEYAZ ÇİZGİLİ
YAPIŞKAN BANTLI
DELİKLİ (PANO TİPİ)
PVC KABLO
KANALLARI
(GRİ / MAVİ)**

**ADHESIVE TAPE PVC
SLOTTED CABLE
TRUNKS**

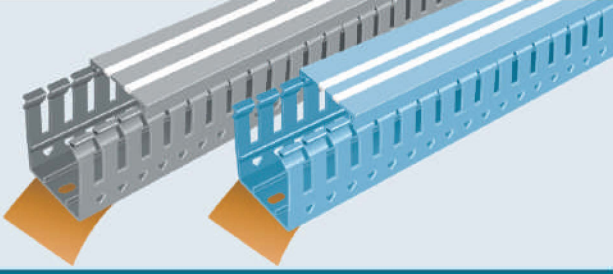
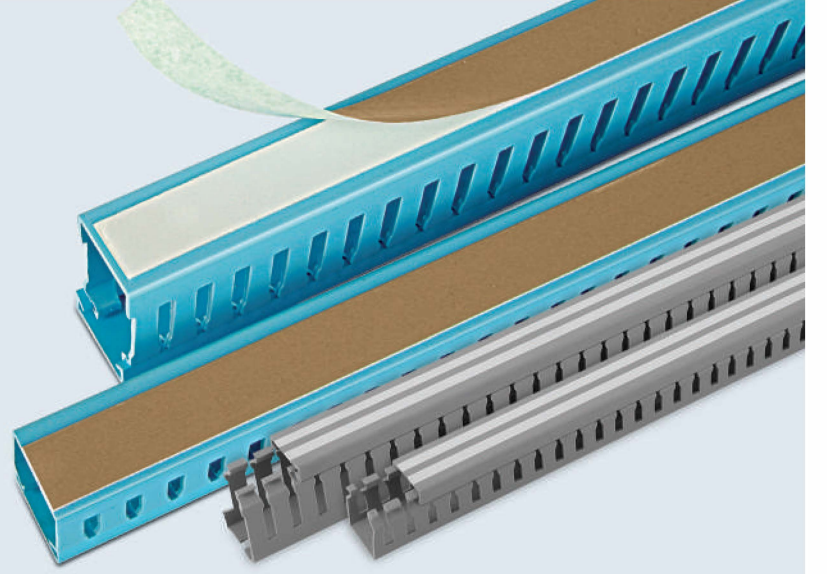

25x25

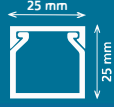

Grey: SBS-6025 025 Blue : SBS-6325 025 White: SBS-6625 025

Uzunluk	Lenght	2m
Kesit	Section	25x25
Ambalaj miktarı (m)	Package total (m)	100m
Ambalaj şekli	Package	Koli-Box
Ağırlık (kg)	Weight (kg)	20.55 kg
Hacim (m ³)	Volume (m ³)	0.0749 m ³

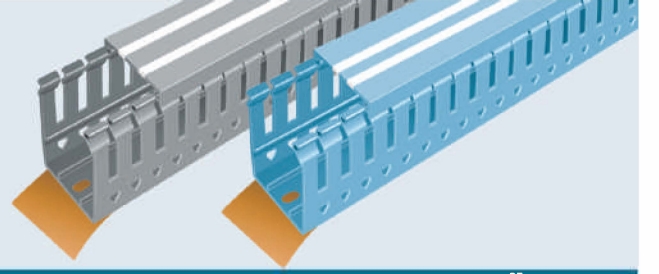

25x40

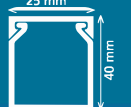

Grey: SBS-6025 040 Blue : SBS-6325 040 White: SBS-6625 040

Uzunluk	Lenght	2m
Kesit	Section	25x40
Ambalaj miktarı (m)	Package total (m)	80m
Ambalaj şekli	Package	Koli-Box
Ağırlık (kg)	Weight (kg)	20.00 kg
Hacim (m ³)	Volume (m ³)	0.089 m ³

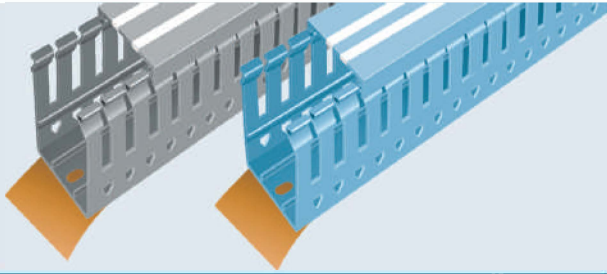

25x60

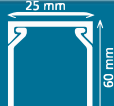

Grey: SBS-6025 060 Blue : SBS-6325 060 White: SBS-6625 060

Uzunluk	Lenght	2m
Kesit	Section	25x60
Ambalaj miktarı (m)	Package total (m)	72m
Ambalaj şekli	Package	Koli-Box
Ağırlık (kg)	Weight (kg)	27.00 kg
Hacim (m ³)	Volume (m ³)	0.126 m ³

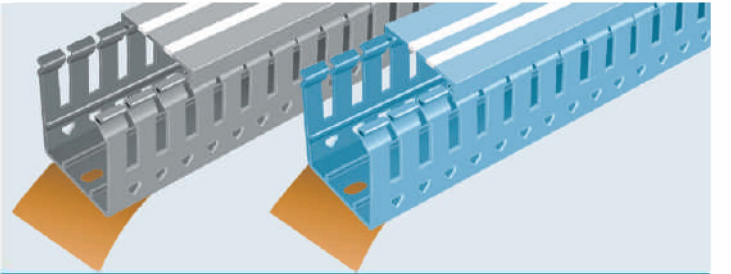

40x40

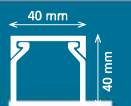

Grey: SBS-6040 040 Blue : SBS-6340 040 White: SBS-6640 040

Uzunluk	Lenght	2m
Kesit	Section	40x40
Ambalaj miktarı (m)	Package total (m)	72m
Ambalaj şekli	Package	Koli-Box
Ağırlık (kg)	Weight (kg)	26.00 kg
Hacim (m ³)	Volume (m ³)	0.126 m ³

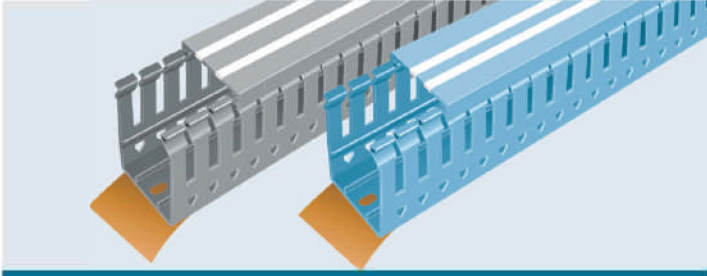

40x60

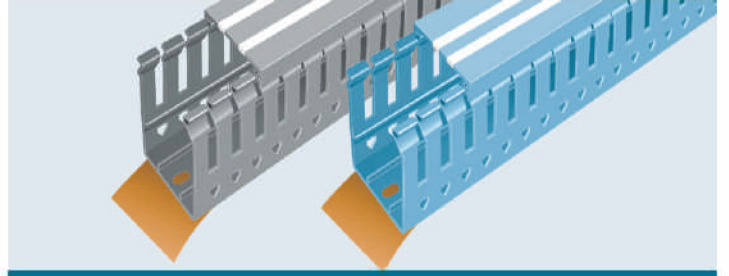
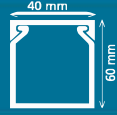

40x80

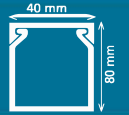

Grey: SBS-6040 060	Blue : SBS-6340 060	White: SBS-6640 060
Uzunluk	Lenght	2m
Kesit	Section	40x60
Ambalaj miktarı (m)	Package total (m)	48m
Ambalaj şekli	Package	Koli-Box
Ağırlık (kg)	Weight (kg)	23.50 kg
Hacim (m ³)	Volume (m ³)	0.126 m ³

Grey: SBS-6040 080	Blue : SBS-6340 080	White: SBS-6640 080
Uzunluk	Lenght	2m
Kesit	Section	40x80
Ambalaj miktarı (m)	Package total (m)	36m
Ambalaj şekli	Package	Koli-Box
Ağırlık (kg)	Weight (kg)	22.50 kg
Hacim (m ³)	Volume (m ³)	0.126 m ³



PANOLAR
BOARDS



HF
Halogen Free

IK10

IP65

200x300x130
ABS PANO
ABS BOARDS

200x300x130
PC PANO
PC BOARDS



OPAK **SBS-120 0 300**

1,40 Kg.

0,084 m³

1 Pcs.



PC **SBS-120 0 325**

1,50 Kg.

0,084 m³

1 Pcs.



250x350x150
ABS PANO
ABS BOARDS

250x350x150
PC PANO
PC BOARDS



OPAK **SBS-120 0 301**

2,20 Kg.

0,014 m³

1 Pcs.



PC **SBS-120 0 326**

2,40Kg.

0,014 m³

1 Pcs.



HF
Halogen Free

IK10

IP65

300x400x170
ABS PANO
ABS BOARDS

300x400x170
PC PANO
PC BOARDS



OPAK

SBS-120 0 302

3,00 Kg.

0,021 m³

1 Pcs.



PC

SBS-120 0 327

3,20 Kg.

0,021 m³

1 Pcs.



300x400x220
ABS PANO
ABS BOARDS

300x400x220
PC PANO
PC BOARDS



OPAK

SBS-120 0 303

3,20 Kg.

0,027 m³

1 Pcs.



PC

SBS-120 0 328

3,40 Kg.

0,027 m³

1 Pcs.



HF
Halogen Free

IK10

IP65

350x500x190
ABS PANO
ABS BOARDS

350x500x190
PC PANO
PC BOARDS



OPAK SBS-120 0 304

4,00 Kg.

0,034 m³

1 Pcs.



PC SBS-120 0 329

4,20 Kg.

0,034 m³

1 Pcs.



400x500x180
ABS PANO
ABS BOARDS

400x500x180
PC PANO
PC BOARDS



OPAK SBS-120 0 305

4,30 Kg.

0,037 m³

1 Pcs.



PC SBS-120 0 330

4,60 Kg.

0,037 m³

1 Pcs.



HF
Halogen Free**IK10****IP65**

400x500x240
ABS PANO
ABS BOARDS

400x500x240
PC PANO
PC BOARDS



OPAK SBS-120 0 306

5,00 Kg.

0,049 m³

1 Pcs.



PC SBS-120 0 331

5,20 Kg.

0,049 m³

1 Pcs.



400x600x200
ABS PANO
ABS BOARDS

400x600x200
PC PANO
PC BOARDS



OPAK SBS-120 0 307

5,20 Kg.

0,049 m³

1 Pcs.



PC SBS-120 0 332

5,40 Kg.

0,049 m³

1 Pcs.



HF
Halogen Free

IK10

IP65

500x700x250
ABS PANO
ABS BOARDS

500x700x250
PC PANO
PC BOARDS



OPAK SBS-120 0 308

8,30 Kg.

0,088 m³

1 Pcs.



PC SBS-120 0 333

8,80 Kg.

0,088 m³

1 Pcs.



600x800x260
ABS PANO
ABS BOARDS

600x800x260
PC PANO
PC BOARDS



OPAK SBS-120 0 309

9,00 Kg.

0,125 m³

1 Pcs.



PC SBS-120 0 334

9,50 Kg.

0,125 m³

1 Pcs.



TEKNİK ÖZELLİKLER TECHNICAL SPECIFICATION

Hammadde	: Cam Elyaf Takviyeli Polyester	Raw Material	: Glass Reinforced Polyester
Kalite Standardı	: EN61439, EN60670-1	Quality Standart	: EN61439, EN60670-1
Renk	: RAL 7035 (Renk Seçenekleri vardır)	Color	: RAL 7035 (There are color options)
Çalışma Sıcaklığı	: -40°+70°C	Operating Temperature	: -40°+70°C
Kapak Açılma Açısı	: 210	Door Opening Angle	: 210
Menteşe	: 2 Adet	Hinge	: 2 Pieces
Kilit	: 1 Adet	Lock	: 1 Pieces
Kilit Seçenekleri	: Üçgen, Kelebek, Yaylı, Sıkıştırılmalı (metal veya plastik)	Lock Options	: Triangle, Butterfly, Springy, Compression (Metal or Plastic)
Koruma Kılıfı	: IP65	Protection Class	: IP65
Yangın Dayanımı	: B2 (İstenildiğinde A1, A2, B1, V0)	Fire Resistance	: B2 (Can change to A1, A2, B1, V0)
UV Dayanımı	: Evet	UV Resistance	: Yes
Nem Dayanımı	: Evet	Humidity Resistance	: Yes
Kimyasal Dayanımı	: Asit ve Bazlara Karşı Tam Koruma	Chemical Resistance	: Full Protection Against acid and base
Aşınma Dayanımı	: Olumsuz hava koşullarına karşı yüksek dayanım	Corrosion Resistance	: High Resistance Against adverse weather conditions
Conta	: Poliüretan dökme conta veya EPDM conta	Gasket	: Polyurathane foam gasket or EPDM gasket
Topraklama Sınıfı	: Class II	Grounding Class	: Class II



SBS-120 0275
200x300x120

Teknik Ölçüler	Technical Dimensions	200x300x120mm
Ağırlık (kg)	Weight (kg)	2,40kg
Hacim (m³)	Volume (m³)	0,007m³
Koli Adedi	Box Quantity	8
Koli Ölçüleri	Box Dimensions	430x610x270mm
Koli Hacmi	Box Volume	0,071m³
Duvar Et Kalınlığı	Wall Thickness	min. 3-4 mm



SBS-120 0276
210x320x130

Teknik Ölçüler	Technical Dimensions	210x320x130mm
Ağırlık (kg)	Weight (kg)	1,92kg
Hacim (m³)	Volume (m³)	0,008m³
Koli Adedi	Box Quantity	8
Koli Ölçüleri	Box Dimensions	480x650x280mm
Koli Hacmi	Box Volume	0,087m³
Duvar Et Kalınlığı	Wall Thickness	min. 3-4 mm



SBS-120 0277
250x300x170

Teknik Ölçüler	Technical Dimensions	250x300x170mm
Ağırlık (kg)	Weight (kg)	2,98kg
Hacim (m³)	Volume (m³)	0,012m³
Koli Adedi	Box Quantity	6
Koli Ölçüleri	Box Dimensions	520x320x540mm
Koli Hacmi	Box Volume	0,090m³
Duvar Et Kalınlığı	Wall Thickness	min. 3-4 mm





SBS-120 0278 300x400x170

Teknik Ölçüler	Technical Dimensions	300x400x170mm
Ağırlık (kg)	Weight (kg)	4,69kg
Hacim (m ³)	Volume (m ³)	0,020m ³
Koli Adedi	Box Quantity	4
Koli Ölçüleri	Box Dimensions	410x620x390mm
Koli Hacmi	Box Volume	0,099m ³
Duvar Et Kalınlığı	Wall Thickness	min. 3-4 mm



SBS-120 0279 350x500x170

Teknik Ölçüler	Technical Dimensions	350x500x170mm
Ağırlık (kg)	Weight (kg)	6,35kg
Hacim (m ³)	Volume (m ³)	0,030m ³
Koli Adedi	Box Quantity	2
Koli Ölçüleri	Box Dimensions	360x520x360mm
Koli Hacmi	Box Volume	0,067m ³
Duvar Et Kalınlığı	Wall Thickness	min. 3-4 mm



SBS-120 0280 400x600x200

Teknik Ölçüler	Technical Dimensions	400x600x200mm
Ağırlık (kg)	Weight (kg)	8,96kg
Hacim (m ³)	Volume (m ³)	0,048m ³
Koli Adedi	Box Quantity	1
Koli Ölçüleri	Box Dimensions	410x610x220mm
Koli Hacmi	Box Volume	0,055m ³
Duvar Et Kalınlığı	Wall Thickness	min. 3-4 mm



SBS-120 0281 500x700x200

Teknik Ölçüler	Technical Dimensions	500x700x200mm
Ağırlık (kg)	Weight (kg)	11,80kg
Hacim (m ³)	Volume (m ³)	0,070m ³
Koli Adedi	Box Quantity	1
Koli Ölçüleri	Box Dimensions	520x720x220mm
Koli Hacmi	Box Volume	0,082m ³
Duvar Et Kalınlığı	Wall Thickness	min. 4-5 mm



SBS-120 0282 600x800x200

Teknik Ölçüler	Technical Dimensions	600x800x200mm
Ağırlık (kg)	Weight (kg)	16,85 kg
Hacim (m ³)	Volume (m ³)	0,105m ³
Koli Adedi	Box Quantity	1
Koli Ölçüleri	Box Dimensions	620x820x260mm
Koli Hacmi	Box Volume	0,132m ³
Duvar Et Kalınlığı	Wall Thickness	min. 4-5 mm



**MENHOLLER ve
RÖGAR KAPAKLARI**

UNDERGROUND
BOARD

andora

PLASTİK & ELEKTRİK
PLASTIC & ELECTRIC

IK10

200x200x200 YER BUATLARI UNDERGROUND BOARDS

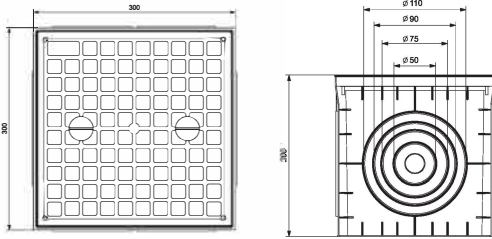
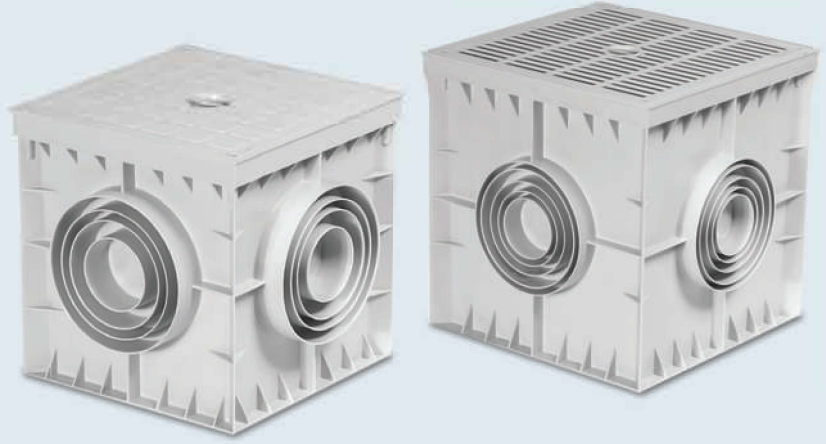
OPAK SBS-140 0 450

21,30 Kg.

0,018 m³

20 Pcs.

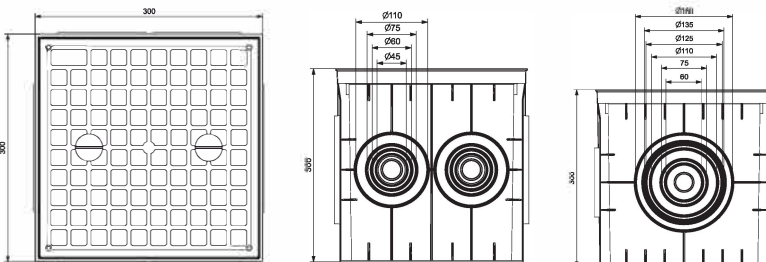
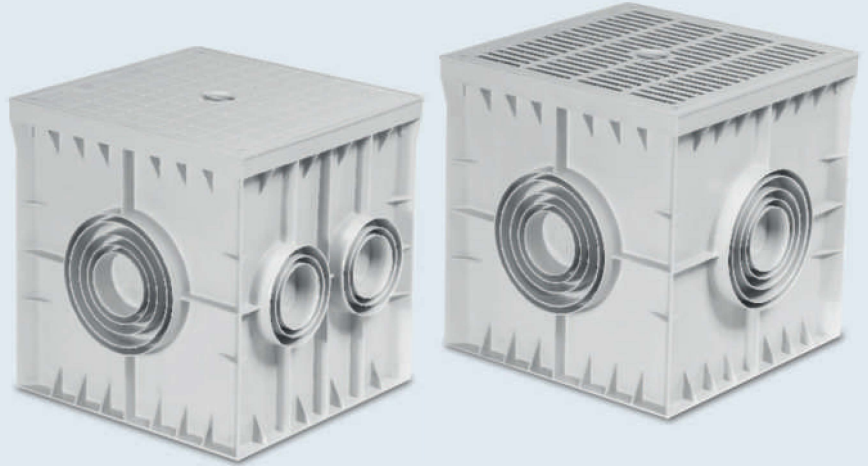

300x300x300 YER BUATLARI UNDERGROUND BOARDS

OPAK SBS-140 0 475

35,20 Kg.

0,034 m³

12 Pcs.



IK10

400x400x400 YER BUATLARI UNDERGROUND BOARDS

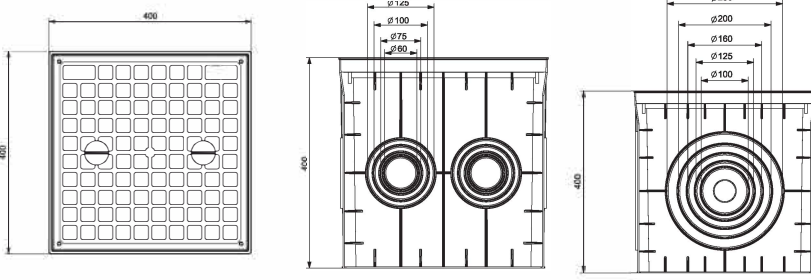
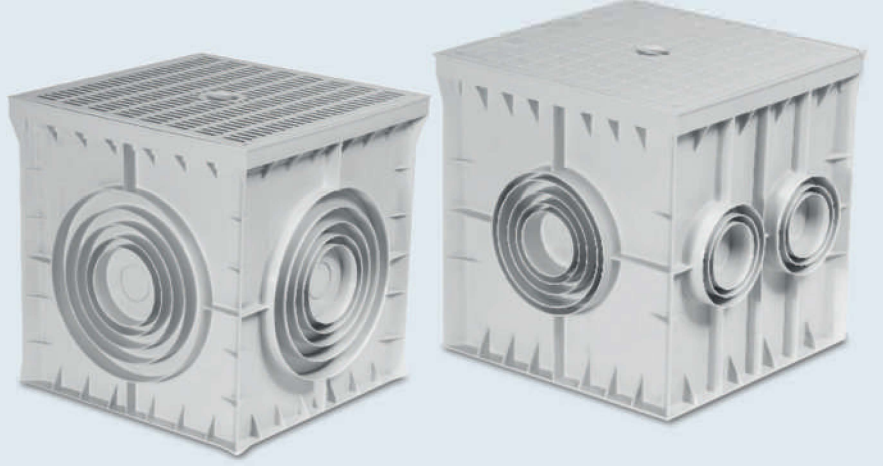

OPAK SBS-140 0 500

23,50 Kg.

0,270 m³

4 Pcs.



550x550x500 YER BUATLARI UNDERGROUND BOARDS

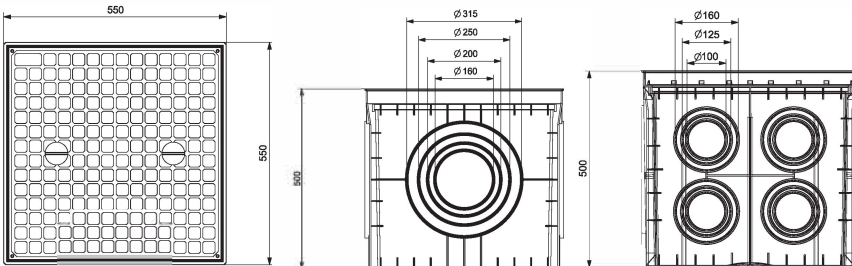
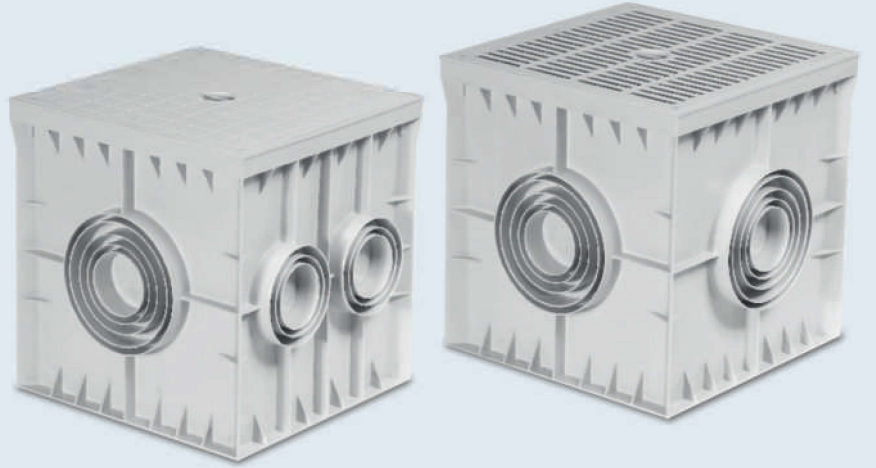

OPAK SBS-140 0 525

19,10 Kg.

0,320 m³

2 Pcs.



1x16A MONOFAZE PRİZ SERİSİ MONOFAZE PLUG AND SOCKET



Ürün Kodu /Code	Açıklama /Description	Ambalaj /Packaging	Kg	m ³
SBS-160 0650	1X16A Topraklı Erkek Fiş 1x16A Earthed Male Plug	300	18.2	0.071
SBS-160 0651	1X16A Topraklı Dişi Fiş 1x16A Earthed Female Plug	180	17.9	0.071
SBS-160 0652	1X16A Tekli Duvar Prizi 1x16A Wall Socket	108	14.7	0.071
SBS-160 0653	1X16A 2'li Grup Priz 1x16A 2 Gang Group Socket	48	12.7	0.071
SBS-160 0654	1X16A 3'lü Grup Priz 1x16A 3 Gang Group Socket	36	14	0.071
SBS-160 0655	1X16A 3'lü Grup Priz 1x16A 3 Gang Group Socket	48	14.2	0.071

3x25A TRİFAZE PRİZ SERİSİ THREE PHASE PLUG AND SOCKET



Ürün Kodu /Code	Açıklama /Description	Ambalaj /Packaging	Kg	m ³
SBS-160 0675	3x25A Trifaze Fiş / 3x25A 3 Phase Plug	240	21.40	0.071
SBS-160 0676	3x25A Trifaze Priz / 3x25A 3 Phase Socket	150	22.70	0.071
SBS-160 0677	3x25A Tekli Duvar Prizi / 3x25A 3 Wall Socket	72	14.30	0.071
SBS-160 0678	3x25A 2'li Grup Priz / 3x25A 2 Gang Group Socket	36	14.30	0.071
SBS-160 0679	3x25A 3'lü Grup Priz / 3x25A 3 Gang Group Socket	36	14.30	0.071
SBS-160 0680	3x25A 1 Adet + 1x16A 1 Adet Grup Priz 3x25A 1 Gang + 1x16A 1 Gang Group Socket	36	18.1	0.071
SBS-160 0681	3x25A 2 Adet + 1x16A 1 Adet Grup Priz 3x25A 2 Gang + 1x16A 1 Gang Group Socket	36	17.9	0.071
SBS-160 0682	3x25A 2 Adet + 1x16A 2 Adet Grup Priz 3x25A 2 Gang + 1x16A 2 Gang Group Socket	36	17.7	0.071

**PANO VE DAĞITIM
KUTULARI**

PANEL AND
DISTRIBUTION
BOXES



SIVA ÜSTÜ SİGORTA KUTULARI SURFACE MOUNT DISTRIBUTION BOXES

			Kg	m ³	Adet
	SBS-110 0228 x2		9.71	0.076	40
	SBS-110 0229 x4		9.62	0.076	30
	SBS-110 0230 x6		11.73	0.095	30
	SBS-110 0231 x9		16.94	0.150	30
	SBS-110 0232 x12		16.36	0.153	20
	SBS-110 0233 x16		18.22	0.175	20
	SBS-110 0236 x18		10.60	0.100	10
	SBS-110 0234 x24		13.83	0.125	10
	SBS-110 0235 x36		18.34	0.157	10
	SBS-110 0225 x1		Kg: 3.40	m ³ : 0.028	Adet: 70
	SBS-110 0226 x1-2		Kg: 2.90	m ³ : 0.028	Adet: 50
	SBS-110 0227 x3-4		Kg: 2.70	m ³ : 0.028	Adet: 30

SIVA ALTI SİGORTA KUTULARI FLUSH MOUNT DISTRIBUTION BOXES

			Kg	m ³	Adet
	SBS-110 0250 x2		8.70	0.076	40
	SBS-110 0251 x4		8.45	0.076	30
	SBS-110 0252 x6		9.99	0.095	30
	SBS-110 0253 x9		15.00	0.150	30
	SBS-110 0254 x12		14.55	0.153	20
	SBS-110 0255 x16		16.00	0.175	20
	SBS-110 0258 x18		9.50	0.100	10
	SBS-110 0256 x24		12.20	0.125	10
	SBS-110 0257 x36		15.80	0.157	10

**TERMOPLASTİK
BUATLAR**

THERMOPLASTIC
JUNCTION BOXES



85x85x40
ANTİGRON BUAT
SQUARE ANTIGRON BOX

85x85x50
PLASTİK BUAT
SQUARE JUNCTION BOX



ANTİGRON SBS-210 11 50

12,50 Kg. 0,100 m³ 240 Pcs.

PLASTİK SBS-210 11 49

12,50 Kg. 0,100 m³ 240 Pcs.

80x120x55
PLASTİK BUAT
JUNCTION BOX

80x120x55
PLASTİK BUAT
JUNCTION BOX
TRANSPARENT



PLASTİK SBS-210 11 51

14,10 Kg. 0,058 m³ 39 Pcs.

TRANSPARAN SBS-210 11 75

14,10 Kg. 0,058 m³ 39 Pcs.

110x110x74
PLASTİK BUAT
JUNCTION BOX

110x110x74
PLASTİK BUAT
JUNCTION BOX
TRANSPARENT



PLASTİK SBS-210 11 52

20,60 Kg. 0,135 m³ 130 Pcs.

TRANSPARAN SBS-210 11 76

20,60 Kg. 0,135 m³ 130 Pcs.

120x150x80
PLASTİK BUAT
JUNCTION BOX

120x150x80
PLASTİK BUAT
JUNCTION BOX
TRANSPARENT



PLASTİK SBS-210 11 53

7,60 Kg.

0,060 m³

30 Pcs.



TRANSPARAN SBS-210 11 77

7,60 Kg.

0,060 m³

30 Pcs.



150x150x80
PLASTİK BUAT
JUNCTION BOX

150x150x80
PLASTİK BUAT
JUNCTION BOX
TRANSPARENT



PLASTİK SBS-210 11 54

9.00 Kg.

0,071 m³

30 Pcs.



TRANSPARAN SBS-210 11 78

9.00 Kg.

0,071 m³

30 Pcs.



190x150x80
PLASTİK BUAT
JUNCTION BOX

190x150x80
PLASTİK BUAT
JUNCTION BOX
TRANSPARENT



PLASTİK SBS-210 11 55

9.95 Kg.

0,088 m³

30 Pcs.



TRANSPARAN SBS-210 11 79

9.95 Kg.

0,088 m³

30 Pcs.



200x200x80
PLASTİK BUAT
JUNCTION BOX

200x200x80
PLASTİK BUAT
JUNCTION BOX
TRANSPARENT



PLASTİK SBS-210 11 56

10,23 Kg.

0,100 m³

24 Pcs.



TRANSPARAN SBS-210 11 80

10,23 Kg.

0,100 m³

24 Pcs.



210x120x74
PLASTİK BUAT
JUNCTION BOX

210x120x74
PLASTİK BUAT
JUNCTION BOX
TRANSPARENT



PLASTİK SBS-210 11 57

14,80 Kg.

0,115 m³

48 Pcs.



TRANSPARAN SBS-210 11 81

14,80 Kg.

0,115 m³

48 Pcs.



280x210x74
PLASTİK BUAT
JUNCTION BOX

280x210x74
PLASTİK BUAT
JUNCTION BOX
TRANSPARENT



PLASTİK SBS-210 11 58

14,10 Kg.

0,146 m³

24 Pcs.



TRANSPARAN SBS-210 11 82

14,10 Kg.

0,146 m³

24 Pcs.



210x120x160
PLASTİK BUAT
JUNCTION BOX

210x120x160
PLASTİK BUAT
JUNCTION BOX
TRANSPARENT



PLASTİK SBS-210 11 59

9,97 Kg. 0,119 m³ 24 Pcs.

TRANSPARAN SBS-210 11 83

9,97 Kg. 0,119 m³ 24 Pcs.

200x200x160
PLASTİK BUAT
JUNCTION BOX

200x200x160
PLASTİK BUAT
JUNCTION BOX
TRANSPARENT



PLASTİK SBS-210 11 60

7,40 Kg. 0,094 m³ 12 Pcs.

TRANSPARAN SBS-210 11 84

7,40 Kg. 0,094 m³ 12 Pcs.

280x210x160
PLASTİK BUAT
JUNCTION BOX

280x210x160
PLASTİK BUAT
JUNCTION BOX
TRANSPARENT



PLASTİK SBS-210 11 61

9,56 Kg. 0,146 m³ 12 Pcs.

TRANSPARAN SBS-210 11 85

9,56 Kg. 0,146 m³ 12 Pcs.

**TEKLİ
KOMBİNASYON
KUTULARI**
SINGLE SOCKET
BOX
214x128x120

HF
Halogen Free

IK10

IP65



SBS-120 03 50

10,40 Kg.

0,105 m³

24 Pcs.



**İKİLİ
KOMBİNASYON
KUTULARI**
DOUBLE SOCKET
BOX
288x218x124

HF
Halogen Free

IK07

IP54



SBS-120 03 52

11,30 Kg.

0,100 m³

12 Pcs.



**DÖRTLÜ
KOMBİNASYON
KUTULARI**
4 SOCKET BOX
380x280x130

HF
Halogen Free

IK07

IP54



SBS-120 03 55

11,40 Kg.

0,140 m³

10 Pcs.



3'LÜ GRUP PRİZ / 3 GANG GROUP SOCKET



Ürün Kodu/ Code	Açıklama / Description	Adet / Quantity
SBS-140 0450	Klemensli / Crimp	40
SBS-140 0451	2 mt. Kablolu / 2 mt. Cable	20
SBS-140 0452	3 mt. Kablolu / 3 mt. Cable	20
SBS-140 0453	5 mt. Kablolu / 5 mt. Cable	15
SBS-140 0454	Anahtarlı Klemensli / Switched Crimp	40
SBS-140 0455	Anahtarlı 2 mt. Kablolu / Switch-2 meters. Cable	20
SBS-140 0456	Anahtarlı 3 mt. Kablolu / Switch-3 meters. Cable	20
SBS-140 0457	Anahtarlı 5 mt. Kablolu / Switch-5 meters. Cable	15

4'LÜ GRUP PRİZ / 4 GANG GROUP SOCKET



Ürün Kodu/ Code	Açıklama / Description	Adet / Quantity
SBS-140 0475	Klemensli / Crimp	30
SBS-140 0476	2 mt. Kablolu / 2 mt. Cable	15
SBS-140 0477	3 mt. Kablolu / 3 mt. Cable	15
SBS-140 0478	5 mt. Kablolu / 5 mt. Cable	15
SBS-140 0479	Anahtarlı Klemensli / Switched Crimp	30
SBS-140 0480	Anahtarlı 2 mt. Kablolu / Switch-2 meters. Cable	15
SBS-140 0481	Anahtarlı 3 mt. Kablolu / Switch-3 meters. Cable	15
SBS-140 0482	Anahtarlı 5 mt. Kablolu / Switch-5 meters. Cable	15

5'Lİ GRUP PRİZ / 5 GANG GROUP SOCKET



Ürün Kodu/ Code	Açıklama / Description	Adet / Quantity
SBS-140 0500	Klemensli / Crimp	20
SBS-140 0501	2 mt. Kablolu / 2 mt. Cable	12
SBS-140 0502	3 mt. Kablolu / 3 mt. Cable	12
SBS-140 0503	5 mt. Kablolu / 5 mt. Cable	10
SBS-140 0504	Anahtarlı Klemensli / Switched Crimp	20
SBS-140 0505	Anahtarlı 2 mt. Kablolu / Switch-2 meters. Cable	12
SBS-140 0506	Anahtarlı 3 mt. Kablolu / Switch-3 meters. Cable	12
SBS-140 0507	Anahtarlı 5 mt. Kablolu / Switch-5 meters. Cable	10

6'LI GRUP PRİZ / 6 GANG GROUP SOCKET



Ürün Kodu/ Code	Açıklama / Description	Adet / Quantity
SBS-140 0525	Klemensli / Crimp	20
SBS-140 0526	2 mt. Kablolu / 2 mt. Cable	12
SBS-140 0527	3 mt. Kablolu / 3 mt. Cable	12
SBS-140 0528	5 mt. Kablolu / 5 mt. Cable	10
SBS-140 0529	Anahtarlı Klemensli / Switched Crimp	20
SBS-140 0530	Anahtarlı 2 mt. Kablolu / Switch-2 meters. Cable	12
SBS-140 0531	Anahtarlı 3 mt. Kablolu / Switch-3 meters. Cable	12
SBS-140 0532	Anahtarlı 5 mt. Kablolu / Switch-5 meters. Cable	10

AKSESUARLAR / ACCESSORIES

Ürün Kodu/ Code	Açıklama / Description	Adet / Quantity
SBS-150 0625	3'lü standart golyat 3 gang - plug socket goliath	30
SBS-150 0626	3'lü papatya golyat 3 gang - plug socket goliath	40
SBS-150 0627	L topraklı erkek fiş Sideway model earthed male plug	50
SBS-150 0628	Topraklı erkek fiş Earthed male plug	50
SBS-150 0629	Topraklı dişi fiş Earthed female plug	40
SBS-150 0630	Ara puar Intermediate switch	150
SBS-150 0631	5'li fiş golyat Goliath 5 gang plug	50
SBS-150 0632	Erkek fiş Male plug	100
SBS-150 0633	Dişi fiş Female plug	100

PLASTİK DUVAR APLİKLER PLASTIC WALL LAMP



Ürün Kodu /Code	Açıklama /Description	Ambalaj /Packaging	Kg	m ³
SBS-170 0704	LALE APLİK ARMATÜR / Lale Wall Lamp	48	12.40	0.110
SBS-170 0705	EYLÜL APLİK ARMATÜR / Eylül Wall Lamp	48	12.40	0.110
SBS-170 0706	OVAL KAFESLİ ARMATÜR SİYAH / Oval Wall Lamp Caged Black	48	14,22	0,199
SBS-170 0707	HAZAL APLİK ARMATÜR / Hazal Wall Lamp	24	8.10	0.105
SBS-170 0708	OVAL ARMATÜR SİYAH / Oval Wall Lamp Black	48	14,72	0,199
SBS-170 0709	PAPATYA APLİK ARMATÜR / Papatya Wall Lamp	24	8.10	0.105
SBS-170 0710	OVAL KAFESLİ ARMATÜR / Oval Caged Wall Lamp	48	13.30	0.110
SBS-170 0711	OVAL ARMATÜR / Oval Wall Lamp	48	14,22	0,199

PLASTİK TAVAN GLOP ARMATÜRLERİ PLASTIC CEILING ARMATURE



Ürün Kodu /Code	Açıklama /Description	Ambalaj /Packaging	Kg	m ³
SBS-170 0724	YILDIZ GLOP ARMATÜR (Q 210mm) / Yıldiz Armature	40	10.20	0.110
SBS-170 0725	GÜNEŞ GLOP ARMATÜR (Q 210mm) / Gunes Armature	40	10.20	0.110
SBS-170 0726	NEHİR GLOP ARMATÜR (Q 210mm) / Nehir Armature	40	10.20	0.110
SBS-170 0727	MAXİ KAFESLİ GLOP ARMATÜR (Q 220mm) / Maxi Caged Armature	24	9,50	0,199
SBS-170 0728	PETEK GLOP ARMATÜR (Q 200mm) / Petek Armature	48	12,24	0,199
SBS-170 0729	PETEK KAFESLİ GLOP ARMATÜR (Q 200mm) / Petek Caged Armature	48	13.44	0.199
SBS-170 0731	YONCA GLOP ARMATÜR (Q 265mm) / Yonca Armature	32	12	0.145
SBS-170 0732	VENÜS GLOP ARMATÜR (Q 265mm) / Venüs Armature	32	12	0.145
SBS-170 0733	NEPTÜN GLOP ARMATÜR (Q 265mm) / Neptün Armature	32	12	0.145
SBS-170 0734	PETEK KAFESLİ GLOP ARMATÜR SİYAH (Q 200mm) / Petek Caged Armature Black	48	13.44	0.199
SBS-170 0735	PETEK GLOP ARMATÜR SİYAH (Q 200mm) / Petek Armature Black	48	12,24	0,199

**TESİSAT
MALZEMELERİ**
INSTALLATION
MATERIALS



POLİETİLEN KANGAL BORULAR (6 ATÜ) SIYAH
POLYTHENE PIPES (6 ATU)

Ürün Kodu Product Code	Açıklama Description	İç Çap Inner Diameter	Dış Çap Outer Diameter	Metre Meter
SBS-180 0725	14	Ø 11.50 mm	Ø 14.65 mm	100
SBS-180 0726	16	Ø 12.75 mm	Ø 15.85 mm	100
SBS-180 0727	18	Ø 14.70 mm	Ø 18.10 mm	100
SBS-180 0728	20	Ø 16.25 mm	Ø 19.85 mm	100
SBS-180 0729	25	Ø 20.79 mm	Ø 24.80 mm	100
SBS-180 0730	32	Ø 26.80 mm	Ø 31.80 mm	100
SBS-180 0731	40	Ø 33.90 mm	Ø 39.80 mm	50
SBS-180 0732	50	Ø 42.90 mm	Ø 49.75 mm	50

POLİETİLEN KANGAL BORULAR (10 ATÜ) SIYAH
POLYTHENE PIPES (10 ATU)

Ürün Kodu Product Code	Açıklama Description	İç Çap Inner Diameter	Dış Çap Outer Diameter	Metre Meter
SBS-180 0750	14	Ø 10.50 mm	Ø 14.45 mm	100
SBS-180 0751	16	Ø 12.00 mm	Ø 15.85 mm	100
SBS-180 0752	18	Ø 14.30 mm	Ø 18.10 mm	100
SBS-180 0753	20	Ø 15.30 mm	Ø 19.85 mm	100
SBS-180 0754	25	Ø 19.80 mm	Ø 24.80 mm	100
SBS-180 0755	32	Ø 25.80 mm	Ø 31.80 mm	100
SBS-180 0756	40	Ø 32.30 mm	Ø 39.80 mm	50
SBS-180 0757	50	Ø 42.00 mm	Ø 49.75 mm	50

HALOJEN FREE BORULAR (6ATÜ) TURUNCU
POLYTHENE HALOGEN FREE PIPES (6ATU)

Ürün Kodu Product Code	Açıklama Description	İç Çap Inner Diameter	Dış Çap Outer Diameter	Metre Meter
SBS-180 0775	14	Ø 11.25 mm	Ø 14.50 mm	100
SBS-180 0776	16	Ø 12.65 mm	Ø 15.85 mm	100
SBS-180 0777	18	Ø 14.60 mm	Ø 18.00 mm	100
SBS-180 0778	20	Ø 16.45 mm	Ø 19.85 mm	100
SBS-180 0779	25	Ø 20.80 mm	Ø 24.80 mm	100
SBS-180 0780	32	Ø 26.80 mm	Ø 31.80 mm	100

HALOJEN FREE BORULAR (10ATÜ) TURUNCU
POLYTHENE HALOGEN FREE PIPES (10ATU)

Ürün Kodu Product Code	Açıklama Description	İç Çap Inner Diameter	Dış Çap Outer Diameter	Metre Meter
SBS-180 0800	14	Ø 10.70 mm	Ø 14.50 mm	100
SBS-180 0801	16	Ø 12.00 mm	Ø 15.85 mm	100
SBS-180 0802	18	Ø 14.60 mm	Ø 18.00 mm	100
SBS-180 0803	20	Ø 15.15 mm	Ø 19.85 mm	100
SBS-180 0804	25	Ø 19.80 mm	Ø 24.80 mm	100
SBS-180 0805	32	Ø 25.25 mm	Ø 31.80 mm	100

PLASTİK SİRİAL (SİYAH)
 POLYTHENE CONDUIT (BLACK)

Ürün Kodu Product Code	Açıklama Description	İç Çap Inner Diameter	Dış Çap Outer Diameter	Metre Meter
SBS-190 0825	14	Ø 15.60 mm	Ø 19.05 mm	100
SBS-190 0826	16	Ø 11.20 mm	Ø 15.85 mm	100
SBS-190 0827	18	Ø 19.60 mm	Ø 24.00 mm	100
SBS-190 0828	20	Ø 14.40 mm	Ø 19.85 mm	100
SBS-190 0829	25	Ø 26.10 mm	Ø 30.75 mm	50
SBS-190 0830	32	Ø 25.90 mm	Ø 31.80 mm	50

PLASTİK SİRİAL (SİYAH) TELLİ
 POLYTHENE CONDUIT (BLACK) WITH GUIDE WIRE

Ürün Kodu Product Code	Açıklama Description	İç Çap Inner Diameter	Dış Çap Outer Diameter	Metre Meter
SBS-190 0850	14	Ø 15.60 mm	Ø 19.05 mm	100
SBS-190 0851	16	Ø 11.20 mm	Ø 15.85 mm	100
SBS-190 0852	18	Ø 19.60 mm	Ø 24.00 mm	100
SBS-190 0853	20	Ø 14.40 mm	Ø 19.85 mm	100
SBS-190 0854	25	Ø 26.10 mm	Ø 30.75 mm	50
SBS-190 0855	32	Ø 25.90 mm	Ø 31.80 mm	50

HALOJEN FREE SİRİAL ALEV YAYAN
 HALOGEN FREE CONDUIT FLAMMABLE

Ürün Kodu Product Code	İç Çap Inner Diameter	Dış Çap Outer Diameter	Metre Meter
SBS-190 0875	Ø 11.20 mm	Ø 15.85 mm	100
SBS-190 0876	Ø 19.60 mm	Ø 24.00 mm	100
SBS-190 0877	Ø 14.40 mm	Ø 19.85 mm	100
SBS-190 0878	Ø 26.10 mm	Ø 30.75 mm	100
SBS-190 0879	Ø 25.90 mm	Ø 31.80 mm	100

HALOJEN FREE ALEV YAYMAYAN SİRİAL
 H. FREE NON FLAMMABLE CONDUIT

Ürün Kodu Product Code	İç Çap Inner Diameter	Dış Çap Outer Diameter	Metre Meter
SBS-190 0900	Ø 11.20 mm	Ø 15.85 mm	100
SBS-190 0901	Ø 19.60 mm	Ø 24.00 mm	100
SBS-190 0902	Ø 14.40 mm	Ø 19.85 mm	100
SBS-190 0903	Ø 26.10 mm	Ø 30.75 mm	100
SBS-190 0904	Ø 25.90 mm	Ø 31.80 mm	100

ÇELİK SİRAL BORULAR STEEL SPIRALS



ÇELİK SİRAL / STEEL SPIRALS

Ürün Kodu Product Code	Açıklama Description	İç Çap Inner Diameter	Dış Çap Outer Diameter	Metre Meter
SBS-240 1425	Çelik Spiral / Steel Spirals	9 mm	13 mm	50
SBS-240 1426	Çelik Spiral / Steel Spirals	11 mm	15 mm	50
SBS-240 1427	Çelik Spiral / Steel Spirals	14 mm	17 mm	50
SBS-240 1428	Çelik Spiral / Steel Spirals	16 mm	18,5 mm	50
SBS-240 1429	Çelik Spiral / Steel Spirals	18 mm	23 mm	50
SBS-240 1430	Çelik Spiral / Steel Spirals	21 mm	25 mm	50
SBS-240 1431	Çelik Spiral / Steel Spirals	26 mm	30 mm	25
SBS-240 1432	Çelik Spiral / Steel Spirals	29 mm	33 mm	25
SBS-240 1433	Çelik Spiral / Steel Spirals	32 mm	33,5 mm	25
SBS-240 1434	Çelik Spiral / Steel Spirals	35 mm	38,5 mm	25
SBS-240 1435	Çelik Spiral / Steel Spirals	37 mm	40 mm	25
SBS-240 1436	Çelik Spiral / Steel Spirals	40 mm	44 mm	25
SBS-240 1437	Çelik Spiral / Steel Spirals	50 mm	56 mm	25

ÇELİK SİRAL BORULAR STEEL SPIRALS WITH INTERNAL WIRE



ÇELİK SİRAL KLAVUZ TELLİ / STEEL SPIRALS WITH INTERNAL WIRE

Ürün Kodu Product Code	Açıklama Description	İç Çap Inner Diameter	Dış Çap Outer Diameter	Metre Meter
SBS-240 1450	Çelik Spiral Klavuz Telli / Steel Spirals With Internal Wire	9 mm	13 mm	50
SBS-240 1451	Çelik Spiral Klavuz Telli / Steel Spirals With Internal Wire	11 mm	15 mm	50
SBS-240 1452	Çelik Spiral Klavuz Telli / Steel Spirals With Internal Wire	14 mm	17 mm	50
SBS-240 1453	Çelik Spiral Klavuz Telli / Steel Spirals With Internal Wire	16 mm	18,5 mm	50
SBS-240 1454	Çelik Spiral Klavuz Telli / Steel Spirals With Internal Wire	18 mm	23 mm	50
SBS-240 1455	Çelik Spiral Klavuz Telli / Steel Spirals With Internal Wire	21 mm	25 mm	50
SBS-240 1456	Çelik Spiral Klavuz Telli / Steel Spirals With Internal Wire	26 mm	30 mm	25
SBS-240 1457	Çelik Spiral Klavuz Telli / Steel Spirals With Internal Wire	29 mm	33 mm	25
SBS-240 1458	Çelik Spiral Klavuz Telli / Steel Spirals With Internal Wire	32 mm	33,5 mm	25
SBS-240 1459	Çelik Spiral Klavuz Telli / Steel Spirals With Internal Wire	35 mm	38,5 mm	25
SBS-240 1460	Çelik Spiral Klavuz Telli / Steel Spirals With Internal Wire	37 mm	40 mm	25
SBS-240 1461	Çelik Spiral Klavuz Telli / Steel Spirals With Internal Wire	40 mm	44 mm	25
SBS-240 1462	Çelik Spiral Klavuz Telli / Steel Spirals With Internal Wire	50 mm	56 mm	25

PVC İZOLELİ ÇELİK SİRALLER

PVC INSULATED STEEL SPIRALS



PVC İZOLELİ ÇELİK SİRALLER / PVC INSULATED STEEL SPIRALS

Ürün Kodu Product Code	Açıklama Description	İç Çap Inner Diameter	Dış Çap Outer Diameter	Metre Meter
SBS-240 1475	PVC İzoleli Çelik Spiral / PVC Insulated Steel Spirals	9 mm	13 mm	50
SBS-240 1476	PVC İzoleli Çelik Spiral / PVC Insulated Steel Spirals	11 mm	15 mm	50
SBS-240 1477	PVC İzoleli Çelik Spiral / PVC Insulated Steel Spirals	14 mm	17 mm	50
SBS-240 1478	PVC İzoleli Çelik Spiral / PVC Insulated Steel Spirals	16 mm	18,5 mm	50
SBS-240 1479	PVC İzoleli Çelik Spiral / PVC Insulated Steel Spirals	18 mm	23 mm	50
SBS-240 1480	PVC İzoleli Çelik Spiral / PVC Insulated Steel Spirals	21 mm	25 mm	50
SBS-240 1481	PVC İzoleli Çelik Spiral / PVC Insulated Steel Spirals	26 mm	30 mm	25
SBS-240 1482	PVC İzoleli Çelik Spiral / PVC Insulated Steel Spirals	29 mm	33 mm	25
SBS-240 1483	PVC İzoleli Çelik Spiral / PVC Insulated Steel Spirals	32 mm	33,5 mm	25
SBS-240 1484	PVC İzoleli Çelik Spiral / PVC Insulated Steel Spirals	35 mm	38,5 mm	25
SBS-240 1485	PVC İzoleli Çelik Spiral / PVC Insulated Steel Spirals	37 mm	40 mm	25
SBS-240 1486	PVC İzoleli Çelik Spiral / PVC Insulated Steel Spirals	40 mm	44 mm	25
SBS-240 1487	PVC İzoleli Çelik Spiral / PVC Insulated Steel Spirals	50 mm	56 mm	25

PVC İZOLELİ ÇELİK SİRALLER KLAUZ TELLİ /

PVC INSULATED STEEL SPIRALS WITH INTERNAL WIRE



PVC İZOLELİ ÇELİK SİRALLER KLAUZ TELLİ / PVC INSULATED STEEL SPIRALS WITH INTERNAL WIRE

Ürün Kodu Product Code	Açıklama Description	İç Çap Inner Diameter	Dış Çap Outer Diameter	Metre Meter
SBS-240 1500	PVC İzoleli Çelik Spiral Klavuz Telli / PVC Insulated Steel Spirals With Internal Wire	9 mm	13 mm	50
SBS-240 1501	PVC İzoleli Çelik Spiral Klavuz Telli / PVC Insulated Steel Spirals With Internal Wire	11 mm	15 mm	50
SBS-240 1502	PVC İzoleli Çelik Spiral Klavuz Telli / PVC Insulated Steel Spirals With Internal Wire	14 mm	17 mm	50
SBS-240 1503	PVC İzoleli Çelik Spiral Klavuz Telli / PVC Insulated Steel Spirals With Internal Wire	16 mm	18,5 mm	50
SBS-240 1504	PVC İzoleli Çelik Spiral Klavuz Telli / PVC Insulated Steel Spirals With Internal Wire	18 mm	23 mm	50
SBS-240 1505	PVC İzoleli Çelik Spiral Klavuz Telli / PVC Insulated Steel Spirals With Internal Wire	21 mm	25 mm	50
SBS-240 1506	PVC İzoleli Çelik Spiral Klavuz Telli / PVC Insulated Steel Spirals With Internal Wire	26 mm	30 mm	25
SBS-240 1507	PVC İzoleli Çelik Spiral Klavuz Telli / PVC Insulated Steel Spirals With Internal Wire	29 mm	33 mm	25
SBS-240 1508	PVC İzoleli Çelik Spiral Klavuz Telli / PVC Insulated Steel Spirals With Internal Wire	32 mm	33,5 mm	25
SBS-240 1509	PVC İzoleli Çelik Spiral Klavuz Telli / PVC Insulated Steel Spirals With Internal Wire	35 mm	38,5 mm	25
SBS-240 1510	PVC İzoleli Çelik Spiral Klavuz Telli / PVC Insulated Steel Spirals With Internal Wire	37 mm	40 mm	25
SBS-240 1511	PVC İzoleli Çelik Spiral Klavuz Telli / PVC Insulated Steel Spirals With Internal Wire	40 mm	44 mm	25
SBS-240 1512	PVC İzoleli Çelik Spiral Klavuz Telli / PVC Insulated Steel Spirals With Internal Wire	50 mm	56 mm	25

ÇELİK SUSTA (TAKVİYELİ) STEEL CABLE PULLER (WIHT GUIDE WIRE)

SUSTALAR
PULLER

Ürün Kodu Product Code	Açıklama Description	Ambalaj Packaging	m ³	Kg
ÇELİK SUSTA (TAKVİYELİ) STEEL CABLE PULLER (WIHT GUIDE WIRE)				
SBS-230 1350	TAKVİYELİ ÇELİK SUSTA (5 MT) STEEL CABLE PULLER (GUIDE WIRE)	40	0.02178	16.50
SBS-230 1351	TAKVİYELİ ÇELİK SUSTA (10 MT) STEEL CABLE PULLER (GUIDE WIRE)	25	0.02178	20.50
SBS-230 1352	TAKVİYELİ ÇELİK SUSTA (15 MT) STEEL CABLE PULLER (GUIDE WIRE)	20	0.02178	23.00
SBS-230 1353	TAKVİYELİ ÇELİK SUSTA (20 MT) STEEL CABLE PULLER (GUIDE WIRE)	15	0.02178	25.50
SBS-230 1354	TAKVİYELİ ÇELİK SUSTA (25 MT) STEEL CABLE PULLER (GUIDE WIRE)	13	0.02178	26.50
SBS-230 1355	TAKVİYELİ ÇELİK SUSTA (30 MT) STEEL CABLE PULLER (GUIDE WIRE)	10	0.02178	20.50
ÇELİK SUSTA (TAKVİYESİZ) STEEL CABLE PULLER				
SBS-230 1375	TAKVİYESİZ ÇELİK SUSTA (5 MT) STEEL CABLE PULLER	40	0.02178	15.50
SBS-230 1376	TAKVİYESİZ ÇELİK SUSTA (10 MT) STEEL CABLE PULLER	25	0.02178	18.50
SBS-230 1377	TAKVİYESİZ ÇELİK SUSTA (15 MT) STEEL CABLE PULLER	20	0.02178	22.50
SBS-230 1378	TAKVİYESİZ ÇELİK SUSTA (20 MT) STEEL CABLE PULLER	15	0.02178	23.50
SBS-230 1379	TAKVİYESİZ ÇELİK SUSTA (25 MT) STEEL CABLE PULLER	13	0.02178	24.50
SBS-230 1380	TAKVİYESİZ ÇELİK SUSTA (30 MT) STEEL CABLE PULLER	10	0.02178	19.50
PLASTİK SUSTA PLASTIC CABLE				
SBS-230 1400	PLASTİK SUSTA (5 MT) PLASTIC CABLE PULLER	50	0.02178	5.75
SBS-230 1401	PLASTİK SUSTA (10 MT) PLASTIC CABLE PULLER	30	0.02178	6.90
SBS-230 1402	PLASTİK SUSTA (15 MT) PLASTIC CABLE PULLER	25	0.02178	8.90
SBS-230 1403	PLASTİK SUSTA (20 MT) PLASTIC CABLE PULLER	20	0.02178	11.95
SBS-230 1404	PLASTİK SUSTA (25 MT) PLASTIC CABLE PULLER	15	0.02178	14.90
SBS-230 1405	PLASTİK SUSTA (30 MT) PLASTIC CABLE PULLER	10	0.02178	18.50

ALEV YAYMAYAN PVC BORULAR

NON-FLAME PROPAGATING PVC PIPES



ALEV YAYMAYAN PVC BORULAR NON FLAMABLE PVC PIPES

Ürün Kodu Product Code	Ölçü Size	İç Çap Inner Diameter	Ambalaj Miktarı Quantity / Pack (m)	Hacim Volume (m ³)	Ağırlık Weight (kg)
SBS-90 0100	Ø 16	Ø13,7	102	0.040	12.3
SBS-90 0101	Ø 20	Ø17,6	102	0.051	16.4
SBS-90 0102	Ø 25	Ø22,2	75	0.068	17.8
SBS-90 0103	Ø 32	Ø28,7	51	0.087	18.2

AKSESUARLAR ACCESSORIES

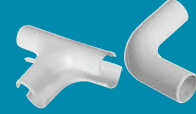

Ek Mufu / Coupling

Ürün Kodu Product Code	Çap Diameter	Ambalaj Packaging
SBS 90 0108	Ø 16	100 Ad./Pcs.
SBS 90 0109	Ø 20	100 Ad./Pcs.
SBS 90 0110	Ø 25	100 Ad./Pcs.
SBS 90 0111	Ø 32	100 Ad./Pcs.

90° Dirsek / 90° Elbow

Ürün Kodu Product Code	Çap Diameter	Ambalaj Packaging
SBS 90 0104	Ø 16	100 Ad./Pcs.
SBS 90 0105	Ø 20	100 Ad./Pcs.
SBS 90 0106	Ø 25	100 Ad./Pcs.
SBS 90 0107	Ø 32	100 Ad./Pcs.

T Eki / T Corner

Ürün Kodu Product Code	Çap Diameter	Ambalaj Packaging
SBS 90 0112	Ø 16	100 Ad./Pcs.
SBS 90 0113	Ø 20	100 Ad./Pcs.
SBS 90 0114	Ø 25	100 Ad./Pcs.
SBS 90 0115	Ø 32	100 Ad./Pcs.

ANTIGRON BORU KROŞELERİ / ANTIGRON PIPE STRAPS



Ürün Kodu / Product Code	Açıklama / Description	Ambalaj / Packaging
SBS-100 0130	16'lik Antigron Boru Kroşesi (Geçmeli Tip) Antigron Pipe Straps Ø16	100
SBS-100 0131	18'lik Antigron Boru Kroşesi (Geçmeli Tip) Antigron Pipe Straps Ø18	100
SBS-100 0132	20'lik Antigron Boru Kroşesi (Geçmeli Tip) Antigron Pipe Straps Ø20	100
SBS-100 0133	25'lik Antigron Boru Kroşesi (Geçmeli Tip) Antigron Pipe Straps Ø25	100
SBS-100 0134	32'lik Antigron Boru Kroşesi (Geçmeli Tip) Antigron Pipe Straps Ø32	100
SBS-100 0135	40'lik Antigron Boru Kroşesi (Geçmeli Tip) Antigron Pipe Straps Ø40	50
SBS-100 0136	16'lik Antigron Boru Kroşesi (Geçmeli Tip) Kapalı Antigron Pipe Straps Ø16 Closed	50
SBS-100 0137	20'lik Antigron Boru Kroşesi (Geçmeli Tip) Kapalı Antigron Pipe Straps Ø20 Closed	50
SBS-110 0158	25'lik Antigron Boru Kroşesi (Geçmeli Tip) Kapalı Antigron Pipe Straps Ø25 Closed	50

BETON ÇİVİLİ KROŞELER / WIRE CONNECTORS

BETON ÇİVİLİ KROŞELER

CABLE STRAP AND WIRE CONNECTORS



Ürün Kodu Product Code	Açıklama Description	Ambalaj Packaging	m ³	Kg
SBS-100 0175	NO.0 Beton Çivili Kroşe (0.75 Yassı Kord.) NO.0 Cable Strap With Concrete Nail 0,75 Flat Cord Cable Strap	20.000	0.0351	15
SBS-100 0176	NO.1 Beton Çivili Kroşe (0.75 Yassı Kord.) NO.1 Cable Strap With Concrete Nail 0,75 Flat Cord Cable Strap	20.000	0.0351	15.25
SBS-100 0177	NO.2 Beton Çivili Kroşe (0.75 Yassı Kord.) NO.2 Cable Strap With Concrete Nail 0,75 Flat Cord Cable Strap	20.000	0.0495	19.70
SBS-100 0178	NO.3 Beton Çivili Kroşe (2x1.5-3x1.5) Yassı Kord.) NO.3 Cable Strap With Concrete Nail 2x1.5-3x1.5 Flat Cord Cable Strap	20.000	0.0592	24.90
SBS-100 0179	NO.4 Beton Çivili Kroşe (2x4 Yassı Kord.) NO.4 Cable Strap With Concrete Nail 2x4 Flat Cord Cable Strap	20.000	0.0670	28.55
SBS-100 0180	NO.5 Beton Çivili Kroşe (2x4-4x4 Yassı Kord.) NO.5 Cable Strap With Concrete Nail 2x4-4x4 Flat Cord Cable Strap	10.000	0.0530	18.75
SBS-100 0181	NO.6 Beton Çivili Kroşe (2x6 Yassı Kord.) NO.6 Cable Strap With Concrete Nail 2x6 Flat Cord Cable Strap	10.000	0.0640	23.30
SBS-100 0182	NO.7 Beton Çivili Kroşe (4x10 Yassı Kord.) NO.7 Cable Strap With Concrete Nail 4x10 Flat Cord Cable Strap	10.000	0.0109	38
SBS-100 0183	NO.8 Beton Çivili Kroşe (3x16+10 Yassı Kord.) NO.8 Cable Strap With Concrete Nail 3x16+10 Flat Cord Cable Strap	6.000	0.110	27.85

